



# Specifications

## DIVISION 4

### Street Stockers

Publication Date:

June 2023

## RSA Titles Policy

- On a state title event date for a RSA division, no race car registered for that division may race or practice at another venue on the same date using a logbook for the division that is holding the title.
- If a state title event is CANCELLED or POSTPONED for any reason and re-scheduled for a later date, the above restriction does not apply to the re-scheduled date (i.e. if the title event moves to another date, race cars registered for that division may race or practice at another venue on the re-scheduled date using a logbook for the division that is holding the title).
- Dual-registered race cars may race or practice using a logbook for a division that is not holding a title on the same day.
- Roof numbers may be changed to avoid duplicate numbers, car numbers must be displayed on front sun visor and rear taillights/ boot lid - minimum height 75mm.

# RSA DIV 4 STREET STOCKERS SPECIFICATIONS

## Introduction

- a) Racing Sedans Australia (RSA) shall direct the enforcement of these specifications in every aspect. The RSA Executive Committee in consultation with the RSA Div. 4 Chief Technical Officer and Technical Advisor/s shall together be the authority for the interpretation of these specifications contained within and any further amendment, clarification, alteration or addition.
- b) Any amendment, clarification, alteration or addition of, or to these specifications will be sent to all RSA clubs (electronic / post) who shall then pass on the relevant information to their competitors and membership as required.
- c) This specification book supersedes all others, and no reference is to be taken from any previous books regardless of their contents. Any amendment or clarification will be sent to all clubs (electronic or post) who in turn will notify all their competitors/members.
- d) **DIVISION 4 - STREET STOCKERS - NO CONTACT PERMITTED.** Direction of racing will be anti-clockwise only.
- e) ***NOTE: This book is to be read and referenced in its entirety. Whilst every effort has been made to have all relevant information pertaining to all issues contained in one area, paragraph or page of this book for quick reference and guidance, it may not have always been practical, possible or achievable for that to have had occurred.***

The contents of this book may not be copied or reproduced in any way without the written authority of Racing Sedans Australia Incorporated.

# Table of Contents

1) INTERPRETATION.....	6
2) SAFETY STANDARDS.....	9
3) IDENTIFICATION NUMBERS .....	11
4) INSTALLATION OF DRIVER RESTRAINT SYSTEM .....	12
Seats .....	12
Seat Belts.....	14
Seat Belt Mountings.....	14
Seat Belt Installation Guide.....	15
5) WINDOW NET .....	17
6) BATTERY .....	17
7) ELECTRICAL WIRING .....	17
8) MIRRORS / CAMERAS / TRANCIEVERS .....	18
9) STARTER MOTORS .....	18
10) BODIES .....	18
11) RUB RAILS .....	21
12) BUMPERS .....	22
Pipe Bumper diagram .....	24
13) FIREWALLS.....	25
14) RADIATORS .....	25
Radiator Support Brace diagram .....	26
15) EXHAUST SYSTEM .....	27
16) FUEL TANK / LINE / TAPS.....	27
17) FUEL.....	28
18) ROLL CAGE .....	29
19) ANTI-SPEAR PLATE / FOOT PROTECTION .....	41
20) SCATTERSHIELD .....	42
21) SUSPENSION .....	43
22) WHEELS/TYRES.....	45
23) WHEEL ARCHES .....	46
24) BRAKES .....	46

25) PEDALS.....	46
26) STEERING .....	47
27) TRANSMISSION .....	48
28) DIFFERENTIAL .....	48
29) DIFF HAT PIVOT PIN STRENGTHENER.....	49
30) ENGINE (CARBURETED).....	50
31) ENGINE (FUEL INJECTED).....	52
32) ELECTRIC WATER PUMPS .....	57
33) BELT GUIDES / TENSIONER.....	58
34) WINGS.....	58
35) SPOILERS.....	59
Appendix 1 – Limited Approvals 2022-23 season .....	60

# 1) INTERPRETATION

- a) Specifications listed in this book are meant as a guide only to building race cars unless otherwise specified. **If "IT" is not mentioned in this book, enquire beforehand for clarification and / or possible approval.**
- b) Before constructing any race vehicle, or adding any part, panel or component thereof of unusual, unconventional or unknown design, full details are to be submitted in writing to the RSA. These submissions are to be with supporting documentation of the issue/s and come via your club to the RSA secretary for processing. A written response will be provided, and if approved, the letter of approval is to be attached to the car's logbook. Prime consideration must be given where any doubt exists, to safety of Drivers, Crew, Officials and Spectators.
- Note:** It may not always be possible for RSA Committee persons and / or Tech Advisors / Officers to provide an immediate verbal or written response to queries relating to specifications.
- c) Prime consideration must be given where any doubt exists, to safety of Drivers, Crew, Officials and Spectators.
- d) It is recommended, whenever possible, that all race cars under construction be inspected by the licensed Club Scrutineer before painting.
- e) All race cars are subject to engine and general measurement before and after any race at the discretion of the Chief Steward, Technical Officer, or Disputes Committee. Any question of legality of a race car, or eligibility of a race driver, must be settled before the commencement of a race meeting.
- f) Notwithstanding anything contained in these specifications or any other Supplementary Regulations that have been approved by the Racing Sedans Australia Inc (RSA), the Scrutineer shall have the right to exclude any vehicle if it is not track worthy, fails to meet specifications in relation to safety or performance advantage, or could become a danger to other competitors or the public or is not constructed in an acceptable manner.
- g) The Scrutineer will make a full report in the Car's Logbook and all defects noted must be rectified before the car is presented for scrutineering again or the vehicle may be excluded from the event.

- h) All material sizes mentioned here within are a minimum unless a maximum is stated. Any Part, Panel or Component not specifically mentioned to be modified must remain standard as per production base model.
- i) Ignorance of Speedway Australia Rules and Regulations and this RSA Div. 4 Specification book and notices shall be deemed as no defence in regard to breaches and/or appeals of same.
- j) Race cars must maintain a neat and presentable appearance, so as not to bring disgrace to the Association. All body panels, bumpers, exhaust systems, etc., must be securely mounted. Any driver who continually loses components on the racetrack will be liable to a fine and/or suspension.
- k) All cars are to be built and repaired to a high standard. All material used is to be of high quality. No bolts/rivets/screws or holes of any sort are to be put in any structural tubing in the roll cage cabin area.
- l) Race cars, when presented for scrutineering, must be in full race condition (i.e. tyres to be used for racing, battery secured, helmet, full race clothing, bonnet and boot may be removed for ease of scrutineering).
- m) Any driver who continually loses components on the racetrack will be liable to a fine and/or suspension.
- n) It is the responsibility of all drivers to ensure their race cars have all sharp protrusions removed when presenting them for any race. The Scrutineer may at any time, direct a driver to remove sharp protrusions, and this must be carried out before entering the track.
- o) Car registration (green sheeting) and payment and issue of an annual / seasonal RSA logbook are required before competition. **Registration of an RSA Vehicle cannot be made by a person under the age of 18 years.**
- p) **PASSENGERS** Where state laws allow. Street Stockers are allowed to carry a passenger for either promotional events or race events.
  - 1) Cars must be daylighted by an authorised RSA Scrutineer through the approved process.
  - 2) All safety requirements set out for driver safety must be mirrored to the passenger side. i.e. NASCAR Bars, Head Plate, Windscreen Mesh, Race Seat, Seat Belts, seat belt mounts etc.

**3) Anyone travelling in the car as a passenger must hold a Speedway Australia Competitors license or Day License for the appropriate division.**

- q)** It is the driver's responsibility to make sure that his/ her car and all internal and external engine components meet the specifications of this Division. Pre-race and post-race vehicle scrutineering inspections may be performed at any race meeting, including state and national titles. If any car fails the after-race specification inspection the driver will be fined / suspended and / or disqualified from the event under Speedway Australia' s Racing Rules & Regulations.
- r) RSA head gasket refund policy:** If the vehicle is found to comply with RSA specifications for the division after post-race scrutineering the RSA will either:
- Directly pay for OEM or standard after-market equivalent parts from an RSA nominated supplier, or
  - Provide a refund that is equivalent to the RSA's cost for supplying replacement parts.

NO REFUNDS will be paid for any vehicle that is found to be in breach of RSA Specifications for the division.

- s)** Vehicles may have fuel checked at any time during the course of any race meeting including state and/or National titles.
- t)** Any driver found with any debris in cabin, boot or pockets, etc. (i.e.: broken glass, bolts, tools etc.) will be refused race clearance to enter the track until the offending items are removed.
- u)** Long hair must be fully contained within suit. No cigarettes / lighters or similar allowed on or used by driver whilst in the race car and / or to track pit requirements. No asthma puffers allowed on driver whilst in the race car. Jewellery that could cause injury (e.g. dangling earrings) is not to be worn.
- v)** Drink bottles (plastic) permitted – maximum size 2 litres. The drink bottle must be suitably and firmly mounted behind driver and to be to the Scrutineer's satisfaction.
- w) NOTE:** RSA will not accept, recommend, or endorse any 'homemade' modifications / alterations to any suspension component/s or to any other OEM vehicle parts. Any fabrication / alteration allowable within these specifications

to these items is to be performed only by persons who are certified specialists in their field of expertise in regard to modifications / repairs to the respectively noted equipment.

- x) RSA Inc. reserves the right to impound and inspect any race car at any time; this may include the removal of any engine for inspection and including the downloading of any information via relevant means if applicable. Cars can be selected at random and ordered to the impound area for dismantling. The Owner and/or Driver of the car must deliver them immediately upon request and supply the necessary manpower and hand tools to accomplish dismantling. Only 2 x persons actually involved in dismantling the car will be allowed in the immediate area of a vehicle being checked. Any persons not having cars in the impounded area, and gaining entry without authorisation, will be ejected.

## 2) SAFETY STANDARDS

**Note:** These are the minimum only safety standards for racing apparel of which may be subject to change at any time. Refer to your local club and/or [www.speedwayaustralia.org](http://www.speedwayaustralia.org) for current up to date regulations and notification of any changes. At the time of publication, the following standards were applicable (copied from Part 16 of Speedway Australia Racing Rules & Regulations, Jan 2023 version):

### APPLICABLE LICENCE CATEGORIES

<b>A</b>	<b><i>All Sedan Divisions</i></b>
<b>SSA</b>	<b><i>All Divisions except Super Sedans</i></b>
<b>B</b>	<b><i>All Divisions except SKAA Karts</i></b>
<b>JD</b>	<b><i>Junior Competitors except Jr F500's</i></b>
<b>V</b>	<b><i>Vintage</i></b>

#### 16.1. Race Suit

Minimum standard of a 1 piece complying with either SFI 3.2A/1, FIA 8856-2000, FIA 8856-2018 or a higher standard of apparel.

## **16.2. Boots**

Comply with SFI 3.3, FIA 8856-2000 or FIA 8856-2018.

Socks must comply with SFI 3.3, FIA 8856-2000 or FIA 8856-2018.

## **16.3. Balaclavas**

Comply with SFI 3.3, FIA 8856-2000 or FIA 8856-2018 and must be worn.

## **16.4. Gloves**

Comply with SFI 3.3, FIA 8856-2000 or FIA 8856-2018.

It is recommended they are the Gauntlet style glove and they must not be modified in any way.

## **16.5. Underwear**

Must be worn and comply with SFI 3.3, FIA 8856-2000 or FIA 8856-2018, must be long sleeved, long legged and must have a neck collar. Drivers must only wear cotton under-garments (e.g. no synthetic boxer shorts), and no under wires on bras. No synthetic attire and no jewellery to be worn by a competitor whilst competing.

## **16.6. Helmets**

Full faced and comply with one of the following: -

- 1) Snell SA-2020
- 2) Snell SA-2015
- 3) BS 6658-85 Type A/FR, AS/NZS 1698:2006 or UN ECE 22.05 standard. (must be no older than 5 years from manufacturer date).
- 4) FIA 8858-2010
- 5) FIA 8859-2015
- 6) FIA 8860-2010

For JD (Junior Divisions) only, the following helmets are also approved for use.

- 7) SFI 24.1
- 8) CMR2016
- 9) CMS2016

## **16.7. Horse Collar**

Compulsory if Driver is not using a Head and Neck Restraint, except Vintage uncaged cars. Must comply with SFI 3.3.

## 16.8. Head and Neck Restraint

Recommended but not mandatory. If worn a Head and Neck Restraint must conform with FIA or SFI 38.1. An AS/NZS 1698:2006 or UN ECE 22.05 helmet must not be modified in any way. Only a Snell or FIA helmet can be modified to wear a Head and Neck restraint device.

Please note that SFI Spec 38.1 Head & Neck restraints must have an in-date compliance sticker on them. The SFI 38.1 Spec requires them to be re-certified every five years. Competitors and officials please take time to check the dates on all Head and Neck Restraints to ensure compliance with these rules.

### **HANS Device Recertification**

Revolution Racegear  
[www.revolutionracegear.com.au](http://www.revolutionracegear.com.au)

### **Safety Solutions / Simpson Hybrid + variants & R3 Frontal Head Restraints**

Simpson Safety Equipment Australia  
[www.simpsonraceproducts.com.au](http://www.simpsonraceproducts.com.au)

### **Defnder Head & Neck Restraints**

Australian Racing Products  
[www.australianracingproducts.com.au](http://www.australianracingproducts.com.au)

## 16.9 Arm Restraints

Arm restraints must be worn in all classes where a window net is not fitted. Must comply with SFI 3.3 or FIA.

## 3) IDENTIFICATION NUMBERS

- a) All race cars must carry the correct identification number as is issued by their club. The numbers must be displayed on BOTH front doors, rear doors or quarter panels. Numbers on doors are to be a minimum height of 40cm high x 7 cm wide strokes, on rear quarter panels minimum 30cm high x 7cm wide strokes, in a contrasting colour and easily read by officials. Club prefix to be minimum height of 10cm high x 2 cm wide strokes. **club prefix optional. IE: Grafton = GCSC.**
- b) **Car number must also be displayed on windscreen visor and rear taillight/Boot lid. Minimum height 75mm.**

- c) Drivers will use upright roof numbers of no more than 16G material, 300mm x 300mm in size - Number must be white on black background. If a top wing is fitted (refer wing section), the roof number may be incorporated on wing (both sides) but must be to the above noted requirements and be made clearly distinguishable amongst any other noted sponsorship signage or wing colouring. A clear border around the number area may be required.
- d) Visiting drivers with conflicting car numbers will alter their roof numbers as notified when it is required for lap scoring purposes. Failure to comply will be dealt with by the Chief Steward.
- e) Drivers' name is to be placed above right-hand front door or on sun visor minimum height 7cm.
- f) Current RSA registration / logbook decal must be affixed to the roll cage / cabin area within easy view for verification.

## 4) INSTALLATION OF DRIVER RESTRAINT SYSTEM

In order for the driver restraint system to be fully effective, considerable thought must be given to the location of mounting points and to proper installation. Many installations comply only with the letter of the rule <sup>1</sup> with no understanding of the purpose, and although effective, to some degree, may cause needless injury to the driver.

### Seats

- a) A purpose-built, one piece, Steel or Aluminium bucket type seat and headrest must be used. Seats may be padded and covered with a fire-resistant type material, the covering being securely attached - maximum thickness 50mm. **NO fiberglass or plastic seats allowed.**
- b) **Minimum of 50mm clearance between helmet and head plate.**
- c) **All seats should be mounted as per manufacturer's installation instructions.**
- d) **Seats must be either:**

- mounted directly to the roll cage or seat frame of roll cage material (minimum 38mm OD x 3mm WT CHS) and/or 50mm x 50mm x 3mm angle iron or stronger or,
  - mounted to the roll cage or seat frame of roll cage material (minimum 38mm OD x 3mm WT CHS) and/or 50mm x 50mm x 3mm angle iron or stronger using the manufacturer's seat mounts for the seat being used.
- e) The seat must be suitably supported by a minimum of 50mm backing plate or washers (to prevent bolts pulling through seat). A minimum of 4 x 8mm bolts must be used - 2 upper (e.g. in seat back) and 2 lower (e.g. in seat base or sides). All seat bolts must be of cup-head design.
- f) All cut-outs for seat belts must be suitably grommeted. No sharp protrusions allowed.
- g) Head rest must be at least 100mm wide. (Cover with suitable material optional).
- h) Side supports to be a minimum of 50mm on all seats at thighs and torso areas. Seat is to be a correct fit for driver.
- i) Side head/shoulder support restraints optional – manufacturer's recommendation on fitment.

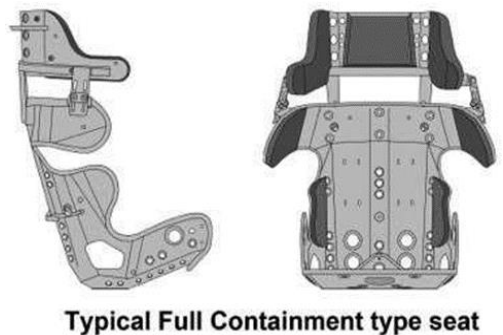
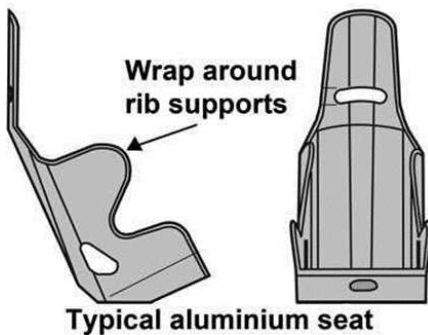

## Seat Belts

- j) All race cars must be fitted with a 5 or 6 mounting point racing harness of the lever latch style, which must be certified by an authoritative body (such as SFI) and must conform to all of their policies including fitment and care/maintenance. Any worn, frayed, rotten or weld spotted holed seat belts are not acceptable, and race cars will not be allowed to enter the track until the seat belts are replaced.
- k) Seat belts must be no older than 2 years from the date of manufacture. Date of manufacture and/or expiry date must be clearly marked on a manufacturer-fitted identification tag.
- l) **Belts, including crotch strap must be a minimum width of 50mm (2 inch).**
- m) All seat belts must be mounted in such a manner to allow their removal between race meetings or when working on the car.

## Seat Belt Mountings

- n) Because of the difference (often vast) in competition race cars and size of drivers, a standard method of mounting is impractical. Good judgment and common sense are needed. The lap belt should be positioned so that it rides across the solid pelvic area and not the soft stomach area or down on the thighs. Seat belts must be mounted to roll cage. Mounting brackets must be welded to roll cage or roll cage cross braces only. Mountings to be equivalent or stronger than roll cage material or 50mm x 50mm x 3mm angle iron. Any race car found with bolts through seat belt webbing will be immediately given an order to replace seat belts. Rear anchorage must be mounted so as to prevent side movement by harness. Scrutineer may require the fitting of a rear harness loop.
- o) **MINIMUM 10mm bolts to be used.**

## Seat Belt Installation Guide

- p) The purpose of this guide is to provide race car drivers, owners and mechanics with additional information on seatbelt installation for upright seats (up to 25° recline seat back angle). This guide is for informational purposes only.

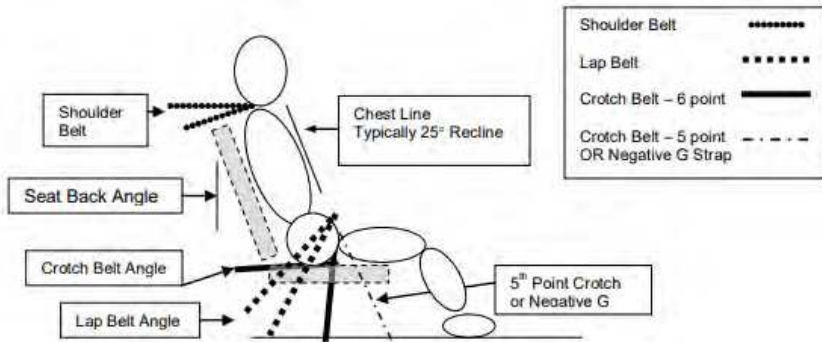

### SHOULDER BELTS

Shoulder Belt Angle: 0 to -20° (-10° optimum) from horizontal

- Clear passage of webbing from top of shoulder (or head and neck restraint) back to the harness bar or mounting point without any interference of the seat openings
- Belts should be as short as possible back to the mounting points

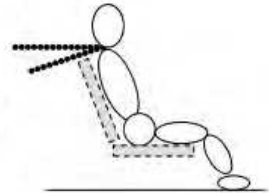

### LAP BELTS

Lap Belt Angle: -45° to -80° from the horizontal

- Belt should ride within the curvature of the pelvic bone preferably just below the iliac crest
- There should be clear passage through the seat opening without webbing being corded or binding on edges of seat openings with a direct path to the mounting point
- The webbing should not ride against any hardware such as seat mounting brackets, bolts, or tabs
- Lap belt adjusters should be clear of the seat openings. Pull-up adjusters if outside the seat opening should be a minimum of 2" below the opening when the lap belt is tightened



- Belts to the mounting point should be as short as possible mounted beside the seat and never behind the seat
- Lap belt should be allowed to pivot freely at the mounting point
- Webbing should be allowed to pull on hardware in plane (straight)

#### Position of the Cam Lock or Latch and Link

- Centered on the body 1 to 2 inches below the belly button when all belts are tightened

### CROTCH BELT – 5-POINT

Sports Car “Shell Type Seat” and aluminum seats with single crotch belt hole forward of the inside seat back from 11 to 13 inches:

- Crotch Belt Angle: Chest line to 20° through the hole
- Crotch Belt should never wrap around the front of the seat – there should be a pass through
- Crotch belt is used only to maintain position of the lap belt

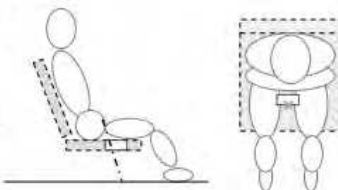

### CROTCH BELT – 6-POINT

Sports Car “Shell Type Seat” and aluminum seats with single crotch belt hole forward of the inside seat back from 10 to 12 inches: *(NOTE: Seats with a single hole positioned more than 12 inches from the inside seat back are designed for 5 point belt installations and may not be as effective for 6-point installations):*

- Crotch Belt Angle: -20° (2” rearward) through the hole
- Two separate anchors 4 to 6 inches apart (∞)

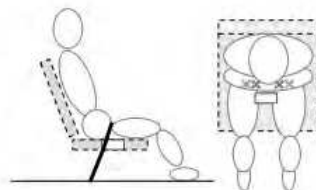

Containment Seats with Crotch belt mounting directly to seat bottom OR through holes provided at the back of the seat bottom: *(Driver is sitting on the Crotch belts)*

- Crotch Belt Angle -10° to -20° from the perpendicular just in front of the crotch with anchors 4 to 6 inches apart (∞)

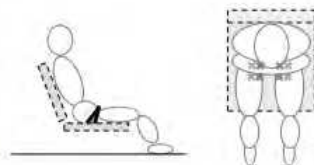

OR

- Crotch Belt Angle Horizontal rearward to under the butt or to the back of the seat (∞)

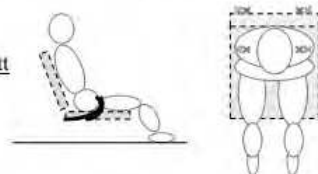

Option (typically for single-seat wide cockpits):

Crotch Belt mounting to the front side of the outboard lap anchors. (Option not illustrated)

Considerations:

- Routing of crotch belts should have a clear and unobstructed path to the mounting point

## 5) WINDOW NET

Must be mirrored on passenger side bar work if passenger seat fitted.

- a) All race cars must be fitted with a propriety type (i.e. a well-made, either from a race wear manufacturer or made by an upholsterer) web style window net (i.e. no string nets and no steel mesh). The window net should, as near as practicable, cover the drivers' side window opening. Triangular window nets are not permitted. Maximum size of holes to be 75mm x 75mm.
- b) Mounting points to be to the Scrutineer's satisfaction. Window net must be mounted to the roll cage using brackets, using minimum of 3mm steel plates and a minimum of 6mm steel rods; and mounted so that it cannot be pushed outwards.
- c) Ocky straps not permitted. Window net must be fastened to inside of car.
- d) All window net mounting brackets must remain inside window and door frames. The purpose of a window net is to stop the head or arms coming outside of the car in an accident or roll-over. Window net must be easy to remove in case of an accident. **Window net MUST be hinged from the bottom.**

## 6) BATTERY

- a) Battery must be securely fastened in a steel frame in the cabin area. **After market weld on/bolt on battery bracket (e.g. Kenco weld on or bolt on steel battery box clamp) permitted.** No plastic bridges.
- b) All batteries (sealed batteries included) must have an effective rubber cover placed over the top to prevent acid spilling in the event of a roll-over. Rubber grommets must be fitted where battery cable passes through metal firewalls.

A highlighted blue triangle is to be placed on outside of car body to show battery location. A white bordered blue triangle permitted for contrast on blue or similar coloured cars.

## 7) ELECTRICAL WIRING

- a) All switches to be grouped together within easy reach of driver with seat belts fastened and clearly marked on/off.

- b) A 'kill switch' must be fitted outside the windscreen in the centre of the cowl panel or on the front of roll cage windscreen centre bar to control all electrical circuits and must be clearly marked on/off in a contrasting and distinctive colour. Dipper switches may be used and it is highly recommended that a 'fairy light' be used to indicate when power is on/off. No other lighting to be fixed to any other body panels or external of vehicle. Electrical wiring must be grommeted where it passes through firewalls etc. and taped to prevent chaffing.

## 8) MIRRORS / CAMERAS / TRANCEIVERS

Mirrors or similar not permitted. Small electronic recording devices (cameras) are permitted on vehicles but need to be securely mounted within the cabin area. Various configurations and designs may need prior approval before fitment. **No** electronic device / screen or similar, capable of receiving live transmission from rear, side or front facing cameras **to driver** permitted in any shape or form whatsoever. Penalties will apply. One-way steward to driver communication devices (raceceivers) and lap scoring transponders are permitted. All other radio or similar telemetry to or from a car is not permitted.

## 9) STARTER MOTORS

At the commencement of the race meeting, car must be capable of starting by an installed starter motor.

## 10) BODIES

- a) Sedans, coupes and hatchbacks only. No utilities, panel vans, station wagons or convertibles permitted. Open to all models except full chassis cars, 4WD, V8, turbo, supercharged or rotary engines. All vehicles to be a production model of a series as it came off the production line.
- b) All vehicles pre 1988 unless noted otherwise must be the same dimension and appearance as model. For models manufactured after 1988, removable body panels and bumpers may be interchanged as follows: Commodore VN to VZ. Falcon EA to EL and AU to FGX. and also able to use body kits and bumpers eg: SS or XR as per model panel kit fitted. If interchanging panels, all applicable panels from the alternate model must be used (ie front guards, bonnet and bumper). Note: interchanging of panels/bumpers on Cortina models TD to TF and Commodore VB to VH only are permitted.

- c) The only panels which may be replaced with fiberglass/aluminium, metal/ (plastic / Lexan replica, minimum thickness 1.5mm) are doors, boot, bonnet, front guards, head and taillight apertures. Front and rear bumper bars may be fiberglass. Removal of original metal rear quarter panels not permitted. Under panel reinforcement plates not permitted. Replacement panels must be securely fastened, guards to be mounted in original position, no under guard bars are permitted, self drilling (tek) screws not permitted. Fiberglass front may be one piece incorporating bonnet and front guards. Single piece front bumper/nosecone combination permitted. Replica panels (especially door panels) are to be shaped/installed as near as practicable to original panel profile design to maintain reasonable car model identification.
  
- d) If replica panels used:- to assist with the fitting of door panels, maximum of 25mm x 25mm x 3mm RHS, may be welded at window and sill height from A to C pillars.
  
- e) All bodywork is to be of professional standard and all cars must be in a presentable condition at all race meetings.
  
- f) To assist with appearance of cars, the roof and rear quarter panels may be covered with fiberglass replica panels securely attached to the steel panel. Self-drilling (Tek) screws etc. or self-tapping screws are not to be used.
  
- g) A steel mesh grille may be used, maximum thickness 5mm. May be filled with fiberglass, plastic or aluminium or with body metal stich welded not fully welded (stich welding is: weld 50mm, miss 200mm).
  
- h) The door pillars may be notched for bar-work but otherwise must remain intact. Doors to be securely fastened (e.g. bolted or welded)
  
- i) No lighting to be fixed to any body panels or external of vehicle. No neon tube LED lights or similar or any other decorative lighting allowed **anywhere** on vehicles. General lighting associated with dash / controls / on-off etc. is permitted.
  
- j) Dash Panel may be removed to assist with roll cage installation. Data logging dashes are not permitted.
  
- k) No full fit-out ('tinning in') of cabin floor permitted. No driver enclosed or 'cockpit' type cabin / dash fit-out areas permitted.

- l) Ballast of any description is not to be carried or fitted anywhere on vehicle e.g. water in tyres, lead, etc. No purposeful placement of track dirt, clay materials etc. into vehicle permitted whatsoever.
- m) Light apertures may be filled using max2mm steel sheet, aluminium, fiberglass or plastic.
- n) Window frame optional. If fitted must be welded or bolted in a minimum of 3 places.
- o) All glass, external mirrors, grills, door handles, door mechanisms, ornamentation including badges, boot rubbers, bull bar, tow bar, helper springs and all flammable material to be completely removed together with manufacturer's fuel tank. Original plastic on C pillar and on wiper arm surround is permitted.
- t) Bonnets to be securely fastened. Four bonnet pins if steel, five for fiberglass, to be 10mm minimum to 15mm maximum mild steel or approved equivalent. Bonnet pins to be in the bonnet, not sides or mudguards. No mounting pins in side of panels, i.e. mud guards. Bonnet lock pins 3mm to 6mm maximum. Heavy duty large reinforcing washers (min. 30mm OD) to be fitted to all bonnet holes on fiberglass bonnet. Similarly, boot lid to be securely fitted, using pins and large washers as for bonnet. The removable boot lid to be securely mounted in four points.
- u) Hinged bonnet and boot lid permitted, using minimum of two pins. Skeletonizing not permitted on hinged panels within 50mm of hinges. The hinged panel must be welded or bolted to the bonnet or boot.
- v) A protective mesh must be fitted to the driver's side of the windscreen. Mesh to be up to maximum 5mm thick x 50mm x 50mm or 50mm x 75mm maximum. There must be a clear vision area in front of the driver of at least 200mm. Name plate may run width of front windscreen, maximum depth at centre of windscreen 200mm. **Must be mirrored on passenger side bar work if passenger seat fitted.**
- w) Drivers' side front floor only may have one (1) drain hole, maximum 30mm - all other holes in driver's side front floor must be filled in.

- x) Side mirror frame and/or front and rear quarter window frame (if fitted) may be filled in only – NO partial or full fill in off any other side / front or rear windows permitted unless noted otherwise. Diagram below.



- y) Spare tyre well area in boot (if fitted) may be removed but then must be filled in using steel / aluminium (max 2mm) and be suitably welded / riveted flat back in place. No openings other than factory size drain holes in boot floor area permitted. Removal of original fuel filler tube in boot area is also permitted but any area then left open is to be filled in using steel / aluminium (max 2mm) and be suitably welded / riveted flat back in place.
- z) (Optional) Removal of factory seat mounts on driver's (RH) side of vehicle only is permitted to allow driver to be seated lower.

## 11) RUB RAILS

- a) If vehicle has skeletonized / skinned doors (fiberglass / aluminium, metal / plastic replica), an outer and inner rub rail must be attached, specifications as follows: (Exception: if the driver's door only has been skeletonized/skinned, a rub rail is optional).
- b) Outer rub rails of 25mm x 25mm x 3mm RHS mild steel or aluminium to be securely mounted against body at a minimum of four points between wheel arches only on both sides. Rub rails not permitted on quarter panel behind rear wheel. Rub rail ends to be closed and taper to 45 degrees.
- c) Inner rub rail bar to be of a minimum 25mm x 25mm x 3mm RHS mild steel, or maximum 42mm x 3mm CHS mild steel and to be securely mounted to the chassis or roll cage at each end.

- d) Bolts must be a minimum 8mm Cup-Head bolts only and be bolted horizontally through outer and inner rub rails. There must be a bolt at each end within 50mm of the end of the rub rail. Bolts (inner and outer) are not to be recessed into RHS rails.

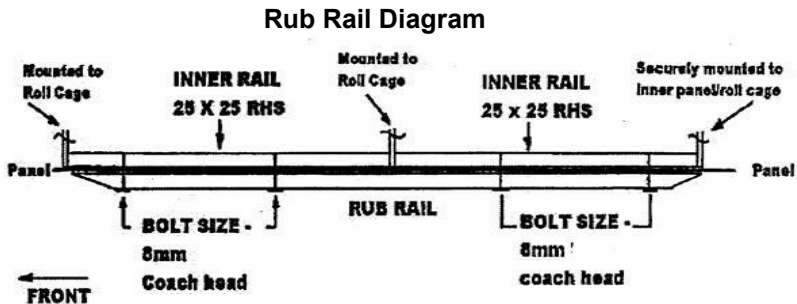

## 12) BUMPERS

- a) Original type bumpers for make and model are to be used **wherever possible** but where an original type bumper is not available, a bumper of similar weight and profile can be used. These bumpers if used are to not detract dramatically from the overall original car body design and enquiry and approval may be required from the RSA and / or Scrutineer before proceeding with fitment.
- b) Original front and rear bumpers must be attached to sub-frame of vehicle using original mounting brackets, or securely mounted to pipe bumpers if used. OEM steel bumpers permitted. No reinforcing bumper pipe, OEM steel, and plastic bumper bar combination permitted. Plastic (no polycarbonate) bumpers may replace OEM steel bumpers. Fibreglass bumpers permitted as per car make and model. Single piece front bumper/nosecone permitted.
- c) All bumpers are to be fastened on the side returns to guard / rear quarter area by the addition of either **cup-head bolts** or riveting. Side returns may be welded to guard / rear quarter area only if OEM steel bumper is fitted.
- d) Plastic bumpers may be additionally secured, by use of maximum 40mm x 3mm flat aluminium or mild steel strap and cup head bolts.
- e) All bumpers (front and rear) can be reinforced with a pipe bumper.  
 Max 42mm x 3mm CHS, 40mm x 40mm x 3.2mm RHS or 50mm x 25mm x 3.2mm RHS only. Note: gussets are not to be used.

- f) Pipe bumpers (if fitted) are to be securely mounted to original bumper mounting points or chassis rails, and pipe mount may extend back to roll cage alongside or inside chassis rails or boot floor. Sides of pipe bumper to be returned as per diagram and welded / bolted to the side of the allowably plated chassis rail area, or welded to the front barwork that extends from the front bar along the chassis rail back to the roll cage. Original bumper mounting points and chassis rail pipe return areas may be plated using maximum 3mm flat plate. Side chassis return rail area plate max 300mm length x 100mm height. One only additional opening permitted in boot floor, maximum 300mm x 300mm.
- g) Front pipe bumpers may be attached back to the cabin roll cage (one bar per side maximum 38mm OD x 3mm CHS) or attach to front chassis rails using maximum 38mm x 3mm CHS or 40mm x 40mm x 3.2mm RHS. Front spreader bar between bumper mounts permitted, maximum 38mm x 3mm CHS. Front and rear pipe bumper to be covered with OEM steel or plastic road car bumper. Bumpers to be radius formed 100mm maximum. Maximum of four mounting points from bumper to chassis on each bumper. Returns and bumpers to be flush fitting with the body within 25mm. Antihook up bars from returns of front and rear bumpers to be extended to the chassis rails, or welded to the front bar work that extends from the front bar along the chassis rail back to the roll cage.
- h) **Rear bumpers only:** May be attached to the cabin roll cage (one bar per side maximum 38mm OD x 3mm CHS) from the rear bumper pipe. If this option is used these bars cannot be raked upwards from rear bumper mount area but are to follow floor lines as near as practical in the boot and cabin area through rear firewall to the main cage. They can also be secured to rear shock towers. One single cross brace may be used between shock towers.
- i) **Rear bumpers only:** Returns of rear bumper may extend as a skid rail against the outside of the body, between bumper and wheel arch, and then extend inwards fastening to either the existing vehicle chassis rail area or internally into the boot area connecting to the rear bumper cabin return pipes (if fitted). Corner plates on top edges of either bumper not permitted. Pipes are not to extend or return through / into rear wheel arch area. One (1) diagonal pipe brace – max 42mm x 3mm CHS - may be fitted in pipe bumper return areas, (as shown on pipe bumper guide diagram page 18).
- j) Bumpers are not permitted to have 'flap / skirt' or spoiler extensions affixed to the bumper in particular the front bumper.

- k) Plastic rear bumpers only may have a portion of the bottom rear facing section removed. The allowance of the cut-out is to be taken from the bottom centre of the rear facing section of the original complete bumper, straight up, and to not exceed 150 mm approximately. The cut-out is to not extend around the bumper corner to the rear quarter panel side areas of the bumper. Cut areas are to have radiused wherever possible to maintain a quality appearance. At no time is the rear bumper cut-out to expose optional bar work or any of the rear body panel sections of the vehicle directly behind the bumper. Due to the wide variance of bumpers on all makes and models, car owners / drivers unsure of allowed alteration to the rear bumper on their particular make and model should contact the scrutineer beforehand for explanation and direction. All internal pipe bumper bar work must not be externally exposed.
- l) To assist in the proficient removal, and in minimising unnecessary further damage to vehicle from the racetrack, a tow / lift chain, sling or similar may be attached suitably to the inside bumper area (rails etc.) or to outside of bumper (front and rear). Chain / sling etc. may mount through / onto pipe bumpers if fitted or in boot area for rear lift chain. Apart from a suitable chain / sling or similar, no external tow hooks or lifting points are to protrude out from bumpers. This tow chain / lifting point is not to be designed as extra strengthening of bumper or bumper area. With variations in designs the fitment will be to the scrutineer's satisfaction.

### Pipe Bumper diagram

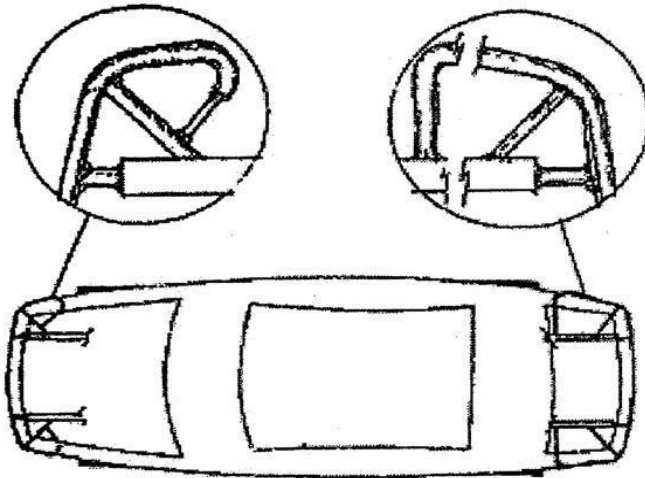

- m) Rear bumper option for BA – BF Falcons. Remove the rear bottom skirt from the rear bumper bar where it clips.
- n) Front bumper option for BA-BF Falcons. Brace at the join of plastic clips using 0.6mm plate or speedway race plastic.

## 13) FIREWALLS

- a) Drivers must be isolated from mechanical, fuel, electrical and exhaust components by firewalls of minimum 0.9mm steel or aluminium. Standard firewalls (front and rear) must remain in original position.
- b) All holes in firewalls must be filled with suitable material. Small holes (up to 3mm) and small gaps around wiring and radiator pipes may be filled with fire resistant sealant. Larger holes to be filled with minimum 0.9mm steel or aluminium.
- c) Rear firewall and parcel shelf to be covered with min 0.9mm steel or aluminium secured with bolts, pop rivets or welded.

## 14) RADIATORS

- a) **Number and position:** A maximum of two (2) radiators are permitted per car. They may be mounted in the original position and/or in the rear of cabin area only. If mounted in the rear of the cabin area, they must be no further forward than the main roll cage hoop. A maximum of one (1) only is permitted in the front of the car (i.e. in the engine bay).
- b) **Fans:** Fans are optional and may be plastic or steel. All fans must have a shroud or suitable guard.
- c) **Cabin mounted radiators:** The top of the radiator and shrouding must not protrude above half rear window height or forward of the main hoop. All standard/OEM/non-racing specific radiators inside cabin must have a suitable shield around the tanks (front and back, top and bottom, left and right), to ensure the driver and other persons are protected in the event of radiator failure or caps blowing. If a professionally fabricated aluminium racing radiator is used with the tanks TIG welded to the core, the tanks are not required to be covered, but radiator cap must be covered. Examples of this are racing radiators produced by KENCO and AFKO.

- d) Pipes leading to and from the radiator must be steel, aluminium or copper pipe. Poly-pipe or re-enforced pressure hose not permitted. All pipes in the cabin area must be covered / lagged and shielded to protect driver in the event of a hose or pipe leak. No household carpet, cloth or similar material permitted to be used to wrap water pipes. Hoses are to be as short as possible and shielded, and radiator outlet pipes must face the rear of the vehicle. All cabin hoses / piping to be restrained in such a way as to minimize 'whipping' of hoses upon separation from radiator/s outlets. Approved hose clamps must be used (2 off recommended wherever possible on each join in cabin area) and there are to be no joins in pipes in front of the radiator between it and the firewall. Aftermarket pipes that fit under the car permitted. Under car pipes must not hang down lower than the lowest point of chassis/transmission tunnel.
- e) Radiators mounted in the cabin area must have overflow hoses going through the floor. If used, overflow bottles are to have a maximum capacity of 2 litres. If overflow bottles mounted in cabin area, they must be fully shrouded including hoses and lines. Radiator cap must be lever vent type and must be shielded.
- f) **Front mounted radiators:** Radiator in engine bay must be in original position. No cutting out of bodywork to make it fit.
- g) **Front radiator support brace:** A front radiator support brace as per diagram below is permitted even if there is no front radiator. Bracing back to edge of sub frame permitted. Maximum material 25mm x 25mm x 3mm RHS tubing or angle iron. Bracing must be no wider than the radiator and must not protrude more than 50mm in front of the radiator, between it and front of the car. (Refer diagram below)

### Radiator Support Brace diagram

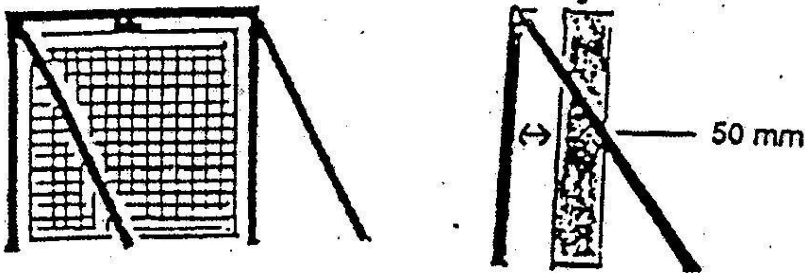

## 15) EXHAUST SYSTEM

- a) Exhaust must be within noise level requirements of each track. (Check before you attend)
- b) Mufflers must be fitted to the engine pipe which must be securely mounted and bracketed.
- c) Exhaust to extend and finish as a minimum past the rear of the driver's seat and must point away from all fuel and brake lines. Floor may be shaped to lift muffler. Exhaust system must not pass through the cabin.
- d) Aftermarket Extractors / Headers permitted on Carby and EFI motors.

## 16) FUEL TANK / LINE / TAPS

- a) The vehicles original OEM manufactured fuel tank is not permitted and must be completely removed.
- b) Fuel tank to be either an approved marine tank, or suitably manufactured tank of minimum 16G steel, stainless steel or 3mm aluminium.
- c) **Maximum capacity 40 litres.** Filler cap must have a tight seal.
- d) Commercially produced plastic racing fuel tanks permitted but must have an earth strap fitted from the plastic fuel cell filler neck to roll cage or chassis as an earth to prevent build-up of static electricity.
- e) Fuel tanks must be securely mounted in an upright position in the boot area to scrutineer's satisfaction. Fuel tank may be mounted onto internal boot bumper return pipes if fitted. Rubber must be placed under and in between all points of contact of tank and holding brackets. Contact area must be a minimum 30cm from rear and sides of boot area. Alternatively, fuel tank may be mounted to boot floor. If tank is mounted to floor, plates are to be used under the mounting points, size 100x100x3mm.
- f) The area beneath the fuel tank must have adequate ventilation in the event of spillage during refuelling. One only additional opening permitted in boot floor, maximum 300mm x 300mm. Filler neck of tank must be inside the boot area. Boot must be able to be opened for scrutineering and inspection of fuel tank area.

- g) Fuel tanks (including filler neck) must be isolated from the driver by a steel / aluminium firewall. No openings are permitted in the rear parcel shelf.
- h) A breather pipe is to be fitted to fuel tank and fitted with either a pig tail to go around tank in two (2) directions or a suitable one-way valve to seal in the event of a roll-over. Pick-up and breather pipes to be silver soldered or braised into tank. The breather pipe exit must pass through boot floor away from exhaust.
- i) Carburettor fuel lines must be a minimum of first grade fuel line or original system, securely fastened. Screw clamps only are to be used on carburettor fuel line connections. Securely fixed flexible fuel hose or OEM type 'Bundy' steel tubing may be used through the car or under the car.
- j) All fuel lines and electrical wiring must be separated and not taped together and must be fitted with grommets when passing through metal firewalls etc. and must be taped and secured where chaffing can occur.
- k) Fuel taps are optional for carburettor engines **only**. If fitted must be clearly marked '**FUEL ON/OFF**'. No fuel taps or similar are permitted on fuel lines (pressure or return) in EFI engines.
- l) **NOTE: Refer page 53 in EFI engine section for further applicable specific EFI fuel line requirements including connections, fitment etc.**
- m) Fuel tank protection bars maybe fitted. Specification for fuel tank protection bar minimum of 38x3mm CHS or 40x40x3mm RHS mounted to rear bar work only and braced forward with 25x25x3mm RHS with a minimum of 100mm clearance of fuel tank.

## 17) FUEL

- a) Fuel - petroleum ULP or PULP pump fuel only, maximum 98 octane RON (Research Octane Number). No additives, No avgas, No racing fuel, No methanol, No E85. Fuel must be supplied by commercial outlet through multi volume network via bowser pump. Fuel may be tested by any means available at any time as determined by the RSA.
- b) **Additives:** The introduction into the combustion chamber/s of additives, either in solid, liquid or gaseous form (e.g. Nitrous oxide) by any means is expressly forbidden.

# 18) ROLL CAGE

## General

- a) The purpose of the roll cage is to prevent the collapse of the cabin area under impact. The cage must extend from behind the driver's seat forward to the windscreen area and incorporate protection for the driver's feet. The roll bars are to constitute a cage type framework, braced fore and aft. All roll cage bar-work is to be inside the body and within the cabin area. The roll cage is to enclose the driver and to be full width and full height of the cabin area.
- b) No bolts/rivets/screws or holes of any sort are to be put in any roll cage structural tubing in the cabin area, except as described for rub rails.
- c) All roll bar material must be of good quality mild steel, sizes for each bar as described in the following sections. Aluminium based materials not permitted Galvanized tubing or welding over threaded tubing not permitted in any structural bar work. Water pipe fittings or malleable fittings are not permitted.
- d) All bends to be made using a pipe bender with the correct size former with no evidence of crimping, wall failure or significant weakening.
- e) **NOTE:** Unless otherwise stated, all roll cage bars **including the Main Hoop bar must be made of one continuous length** of the appropriate material and built using fusion welding techniques only. Gussets may be required to welded joints.
- f) Roll cage pipe padding is recommended around / near driver area to cushion the effects of any impact.
- g) There are many variations in roll cage design mainly due to the different body shapes, especially in later models. These roll cage specifications describe the minimum elements that constitute an acceptable roll cage. Roll cages which exceed the requirements of the specifications through additional bars or the use of larger diameter tube are also acceptable provided all roll cage bar-work is to be inside the body and within the cabin area, and the roll cage is passed as safe. If in doubt, contact the RSA or State technical officer for the class to get a ruling as covered in this books 'Interpretation' section.
- h) The specifications for the minimum elements of a roll cage follow. Unless otherwise specified, all bars are compulsory. Any additional roll cage bars must

be of roll cage material, i.e. Minimum AS1163 Gr300 38mm OD x 3.0mm wt. CHS.

- i) If unsure in any aspect of the design or assembly of cage or any other roll cage compliance as stated within, contact the RSA for clarification. **NOTE:** This applies especially when using, modifying or retro-fitting an earlier built existing cage.

## 1) Floor Bars

Material: Minimum AS1163 Gr300 38mm OD x 3.0mm wt. CHS or  
Minimum 50mm x 50mm x 3mm RHS or  
Minimum 50mm x 50mm x 3mm Angle iron

The floor bars run from front to rear inside the cabin on each side as close to floor as practicable. At a minimum they must extend from the rear of the main hoop to front of the foot protection on the driver's side and the front of the forward roll cage leg on the passenger's side. They may extend as far forward or back as possible (e.g. to the rear wheel arch) as long as they are within the cabin area. They must be securely welded to the floor panels/sills.

## 2) Cross Braces

Material: Minimum AS1163 Gr300 38mm OD x 3.0mm wt. CHS.

The cross braces run from side to side between the floor bars as close to floor as practicable. The rear cross brace must line up with the main hoop. The front cross brace must be in the area from the front of the seat to the firewall. There are multiple options for front cross brace designs – refer to roll cage diagrams.

## 3) Main Hoop

Material: Minimum AS1163 Gr300 38mm OD x 3.0mm wt. CHS.

The one-piece main hoop runs vertically from the floor bars on each side of the cabin following the profile of the doors and roof behind the driver and be within 50mm of the sides of the roof at the narrowest point.

## 4) Main Hoop Brace

Material: Minimum AS1163 Gr300 38mm OD x 3.0mm wt. CHS.

A one-piece diagonal brace must be fitted in the main hoop behind the driver's head from top right to bottom left. The top right mounting point must be within 250mm of the corner of the main hoop.

The use of a two-piece main roll hoop diagonal brace is permitted only if a full length left to right one-piece seat back/shoulder belt mount bar between main roll hoop down legs is used as shown below. The diagonal brace must be fitted inside the main hoop behind the driver's head from top right to bottom left. The top right mounting point must be within 250mm inward of the top right-hand corner of the main hoop.

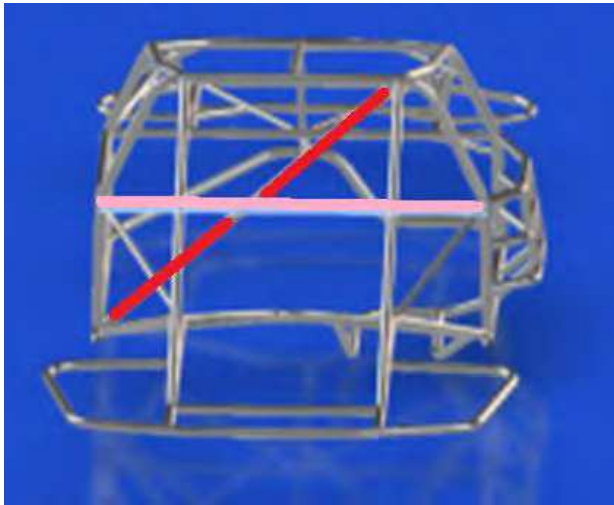

### Main Hoop Cruciform Brace (optional)

Material: Minimum 32mm OD x 3.0mm wt. CHS.

A second brace may be fitted to form a crucifix with the main hoop brace. This brace runs from top left to bottom right.

## 5) Seat back support

Material: Minimum AS1163 Gr300 38mm OD x 3.0mm wt. CHS.

The seat back support runs horizontally from the main hoop brace to the main hoop. It is also used as a seat belt mounting point for the shoulder belts.

## 6) Roll cage legs

Material: Minimum AS1163 Gr300 38mm OD x 3.0mm wt. CHS.

The one-piece roll cage legs run from the top corners of the main hoop to the floor bars near the front door pillars. They must follow the A pillar line in the windscreen area, following the line of the A pillars.

**Exception:** Cars with severe rake of the windscreen. Angle of roll cage A-pillar bar to be of not less than 45 degrees down from roof bar. May require a quarter window bar to be fitted. If a pillar bar does not follow A pillar line and is 45 degrees, additional sub frame cross brace from front of foot protection to LHS is required.

### 3<sup>rd</sup> Roll cage leg (optional)

Material: Minimum AS1163 Gr300 38mm OD x 3.0mm wt. CHS.

A 3<sup>rd</sup> roll cage leg running from the centre of the main hoop to the centre of the front cross brace may be fitted as an alternative to the centre roof bar and the centre windscreen bar. If this bar is fitted, the top and bottom windscreen bars may be fabricated in two pieces (one on each side of the 3<sup>rd</sup> roll cage leg).

## 7) Quarter window bars

Material: Minimum 25mm OD x 3.0mm wt. CHS.

A quarter window bar, if required because of excessive rake or a long roll cage, must be fitted on both sides and installed from the top NASCAR bar to roll cage leg at top half of pillar.

## 8) Top Windscreen bar

Material: Minimum AS1163 Gr300 38mm OD x 3.0mm wt. CHS.

The top windscreen bar runs between the roll cage legs at the top of the windscreen area. It must be within 50mm of roof and 100mm of windscreen at front roll cage leg on side elevation.

## 9) Lower Windscreen bar

Material: Minimum AS1163 Gr300 38mm OD x 3.0mm wt. CHS.

The lower windscreen bar runs between the roll cage legs at the bottom of the windscreen area.

## 10) Centre roof bar

Material: Minimum 32mm OD x 3.0mm wt. CHS.

The centre roof bar runs from the centre top of the main hoop to the centre of the top windscreen bar.

## 11) Centre windscreen bar

Material: Minimum 25mm OD x 3.0mm wt. CHS.

The centre windscreen bar runs from the centre of the top windscreen bar to the centre of the bottom windscreen bar.

**Additional bar - lower windscreen bar to cross brace - recommended** It is recommended that an additional bar of 38mm OD x 3.0mm wt. CHS be fitted between the lower windscreen bar and the forward cross brace if the cross brace is located sufficiently forward in the cabin so this bar is vertical or close to vertical. This bar is optional.

## 12) Driver's side door bars & spacers

Material: Minimum AS1163 Gr300 38mm OD x 3.0mm wt. CHS.

On the driver's (right) side three (3) horizontal side bars, curved out ('NASCAR' style) to the door skin, must be fitted between the main hoop and the front roll cage leg, evenly spaced between the window sill and the floor bar.

A minimum of two vertical spacer bars, evenly spaced between the front and rear roll cage legs, must be fitted between the floor bars and the top horizontal bar. The top horizontal NASCAR bar will be within 50mm of the windowsill.

**Optional:** One (1) only middle (not the top bar) driver's NASCAR door bar may extend or be extended through to the front of the rear wheel arch area and attach to the main hoop via a short bar forming a 'T' junction. This bar is not to be used as an inner rub rail mount.

**\*\*LEFT HAND SIDE (PASSENGER SIDE) TO BE MIRRORED OF DRIVERS SIDE IF PASSENGER SEAT FITTED.** Including foot protection, anti-spear plate and head plate.

## 13) Passenger's side door bars – NASCAR Option

Material: Minimum AS1163 Gr300 38mm OD x 3.0mm wt. CHS.

On the passenger's (left) side two (2) horizontal side bars, curved out ('NASCAR' style) to the door skin, must be fitted between the main hoop and the front roll cage leg, evenly spaced between the window sill and the floor bar.

A minimum of one vertical spacer bar, evenly spaced between the front and rear roll cage legs, must be fitted between the floor bars and the top horizontal bar. The top horizontal NASCAR bar will be within 50mm of the window sill.

**Optional:** One (1) only middle (not the top bar) passenger's NASCAR door bar may extend or be extended through to the front of the rear wheel arch area and attach to the main hoop via a short bar forming a 'T' junction. This option is only available with the NASCAR option for passenger door bars.

This bar is not to be used as an inner rub rail mount.

## Passenger's side door bars – Alternative

Material: Minimum AS1163 Gr300 38mm OD x 3.0mm wt. CHS.

On the passenger's (left) side one (1) straight (not curved) horizontal side bar, must be fitted between the main hoop and the front roll cage leg, within 50mm of the windowsill.

An additional diagonal bar may be fitted (shown in diagram) between the main hoop and the front roll cage leg under the horizontal door bar from rear to corner to bottom front corner.

## 14) Rearward brace bars (optional)

Material: Minimum 34mm OD x 3mm wt. CHS

The rearward brace bars run from the top rear main hoop down onto cabin or boot floor sub-frame, firewall, parcel tray or wheel arch areas (approx. 45 degrees) and may be crucifix. Bars in boot area must terminate at least 300mm inward from rear boot panel. Bars may attach down to rear bumper return pipes (if fitted). They must attach to the rearward side of the main hoop within 100mm of the centre of the top radius.

## 15) Head Plate

**Must be mirrored on passenger side bar work if passenger seat fitted.**

Material: Minimum 3mm steel plate or 5mm aluminium alloy plate.

A full head protection plate must be fitted to fully cover the area between the main hoop and top windscreen bar from the centre roof bar to the top of the roll cage leg on the drivers' side. When sitting, and belted in seat, there must be a minimum of 50mm clearance between helmet and head plate. Steel plate may be welded on or bolted on, alloy plate must be bolted on.

Welded option: to be mounted from above the roll cage bars and to be a minimum stitch welded to roll cage.

Bolted option: to be mounted from above the roll cage bars and bolted to minimum 10 tabs (3 tabs on each side, 2 front and 2 rear) of 50mm x 50mm x 3mm steel welded to roll cage using minimum 10 x 8mm high tensile bolts (one bolt per tab).

## 16) Front Bar Work

Material: Minimum AS1163 Gr300 38mm OD x 3.0mm wt. CHS.  
Maximum 42.5mm OD x 3.2mm wt. CHS.

**Optional:** Front bar work permitted from the internal roll cage into the engine bay area.

The attachment point at the internal roll cage may be either:

- the lower windscreen bar,
- the lower centre windscreen bar below the lower windscreen bar,
- the front floor cross brace or,
- the front roll cage legs forward of the A pillar.

The attachment point in the engine bay may be either:

- the suspension towers (one bar per tower), and/or
- the chassis rail or the front pipe bumper bar returns.

**Optional:** Front bar work permitted from the suspension towers to chassis rail or front pipe bumper bar returns behind the radiator support panel and a minimum of 300mm behind the front pipe bumper, maximum 38mm OD x 3.2mm wt. CHS. Max. 100mm x 100mm x 3mm plate may be welded to towers for support.

## Roll Cage Diagrams

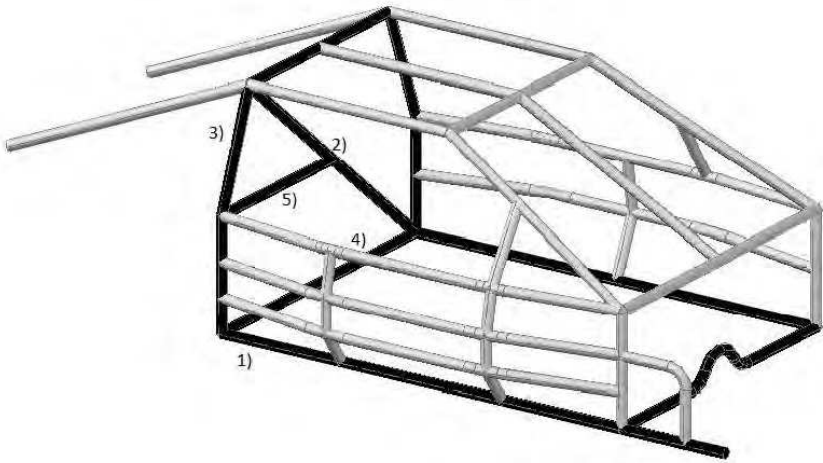

- 1) Floor bars
- 2) Cross braces
- 3) Main hoop
- 4) Main hoop brace
- 5) Seat back support

### Front Cross brace design options

A. Old Style Cross Brace

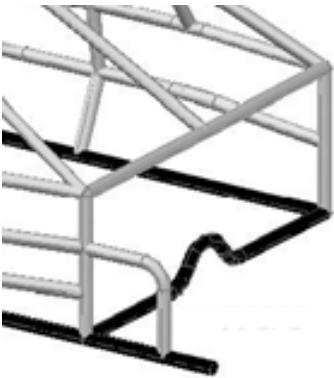

B. Later models with higher tunnels





C. 'Fuller' Cross Brace



D. As used in other divisions

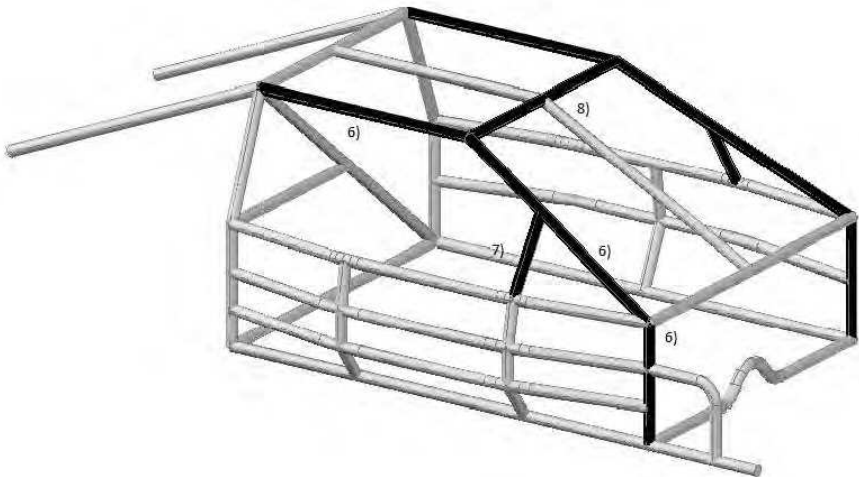

- 6) Roll cage legs
- 7) Quarter window bars
- 8) Top windscreen bar

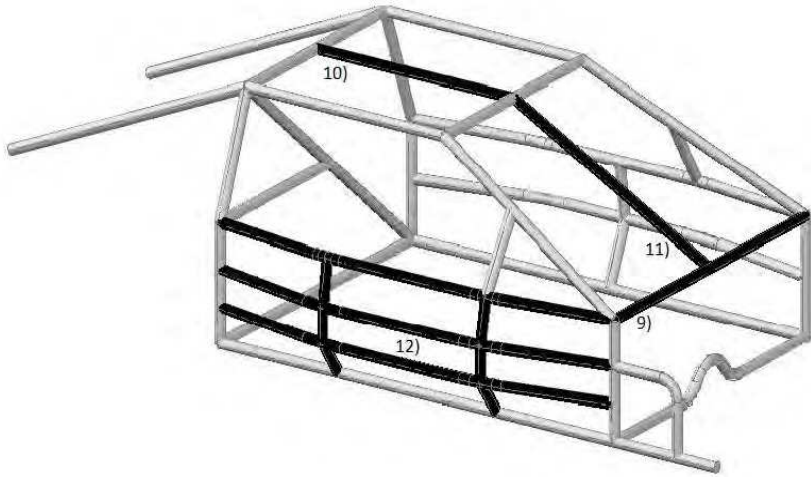

- 9) Lower windscreen bar
- 10) Centre roof bar
- 11) Centre windscreen bar
- 12) Driver's door bars and spacers

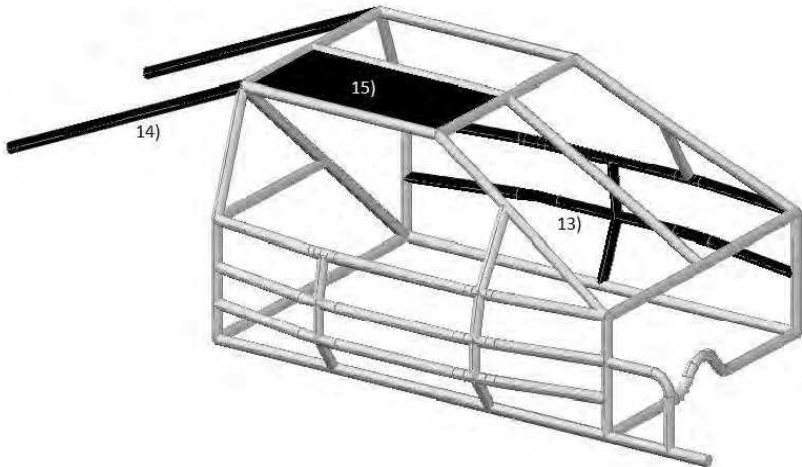

- 13) Passenger door bars (NASCAR option)
- 14) Rearward brace bars
- 15) Head pate

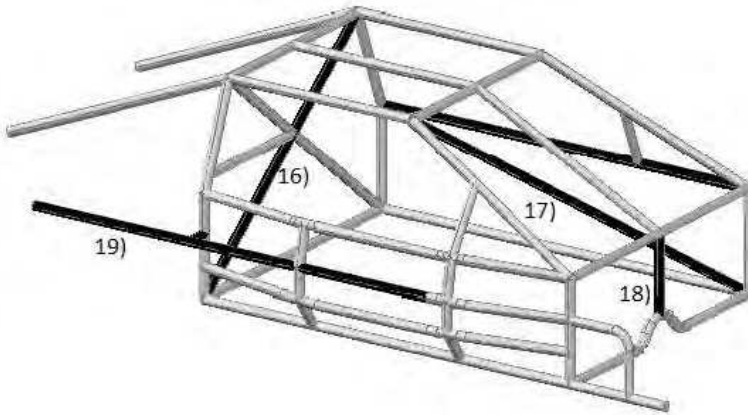

- 16) Cruciform main hoop brace (optional)
- 17) Passenger side door bars (alternative to NASCAR option)
- 18) Additional lower centre windscreen bar (optional / recommended)
- 19) Optional extended door bar (driver's side only shown)



Bumper-to-bumper bar work (does not show optional front bar work to suspension towers as described in section 16 above). The bar work from the bumpers to the cage is described in Bumpers section, ref 12.g and 12.h.

The 'halo bar' style roll cage as shown above is permitted as an option to the roll cage designed described in the main section. The 'halo bar' extends forward along

the inside of the door frame following the roof line from the main hoop to the top of the windscreen and back to the main hoop on the opposite side. The forward legs run from the 'halo bar' down the inside of the A-Pillar and inside door frame to the floor bars. Material to be as per roll cage bar work (minimum AS1163 Gr300 38mm OD x 3.0mm wt. CHS).

## 19) ANTI-SPEAR PLATE / FOOT PROTECTION

### Anti-Spear Plate

Must be mirrored on passenger side bar work if passenger seat fitted.

- a) Material: Minimum 3mm steel plate or 5mm aluminium alloy plate

Either a one-piece plate or 3 individual plates of 3mm steel or 5mm alloy must be fitted to form an anti-spear external cage plate on the driver's side NASCAR bars from floor-line to window sill bar, forward of the first vertical door bar to the front leg of roll cage. Not to be lightened by drilling. The anti-spear plate may be extended to 2<sup>nd</sup> spacer bar on the driver's side NASCAR bars as an option.

Steel plate: to be a minimum stitch welded (preferably fully welded) to roll cage.

Alloy plate one-piece plate: to be bolted to minimum 6 tabs of 50mm x 50mm x 3mm steel welded to roll cage using minimum 6 x 8mm high tensile bolts (one bolt per tab).

Alloy plate individual pieces: each plate to be bolted to minimum 4 tabs of 25mm x 25mm x 3mm steel welded to roll cage using minimum 4 x 8mm high tensile bolts (one bolt per tab).

### Foot Protection

Must be mirrored on passenger side bar work if passenger seat fitted.

- b) Material: Minimum 3mm steel plate or 5mm aluminium alloy plate  
Minimum AS1163 Gr300 38mm OD x 3.0mm WT CHS.

Foot protection bar work is mandatory if drivers' feet are past the A pillar bar whilst the driver is seated in the car in race position. The minimum requirement for foot protection a curved bar of minimum 38mm OD x 3.0mm WT extending forward from the A-pillar bar to the floor bar in the footwell of the driver's side.

The internal area formed by the foot protection bar must be filled with minimum 3mm steel plate either stitch or fully welded to the foot protection bar.

Alloy plate one-piece plate: to be bolted to minimum 4 tabs of 50mm x 50mm x 3mm steel welded to roll cage using minimum 4 x 8mm high tensile bolts (one bolt per tab).

If practical, straight leg fitment of driver's side A-pillar bar through to subframe floor bar intersecting at firewall, is permitted as an option for the foot protection bar.

An optional support bar min 25mm OD x 3mm WT maybe fitted from the foot protection bar to bar work to the left.

### Anti Spear Plate / Foot Protection diagram

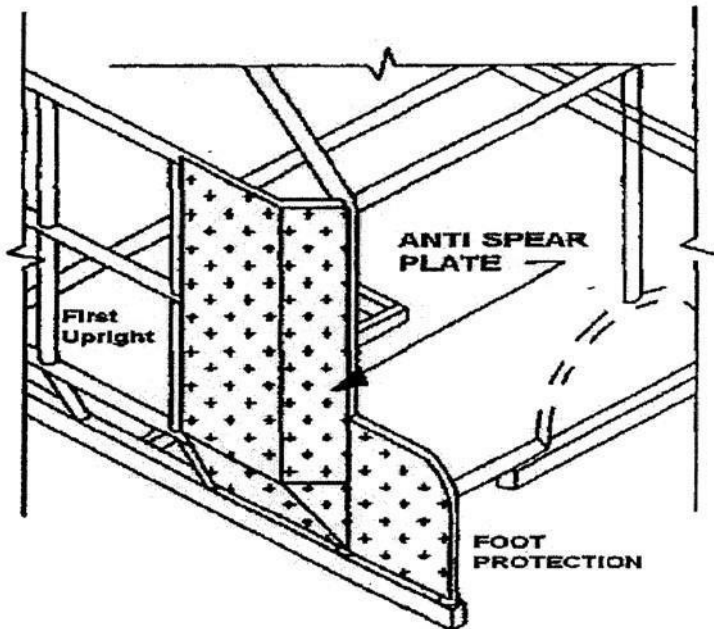

## 20) SCATTERSHIELD

It is recommended that a 3mm Scatter shield be securely attached to cover the upper 180 degrees of the bell housing. This is to protect the driver from a clutch explosion.

## 21) SUSPENSION

- a) **NOTE:** The RSA will not accept, recommend or endorse any 'homemade' modifications / alterations to any suspension component/s or to any other OEM vehicle parts. Any fabrication / alteration allowable within these specifications to these items are to be performed only by persons who are certified specialists in their field of expertise in regard to modifications / repairs to the respectively noted equipment.
- b) Suspension components and mounting points are to remain standard as per model unless specifically mentioned. Suspension mounting points cannot be moved.
- c) Strengthening, cutting or welding of components not permitted, unless specifically mentioned.
- d) Shock absorbers with external canisters not permitted. Double-adjustable shock absorbers not permitted.

### **Modifications permitted are as follows: -**

- e) Springs may be changed for aftermarket items of the same type (i.e. coil for coil, leaf for leaf). Original mounting positions must be used.
- f) Aftermarket Shock Absorbers are permitted, but not air Shock Absorbers. No coil-over allowed. **Clarification:** All aftermarket (store bought, includes adjustable) shock absorbers can be used as long as they fit into original mounting points of vehicle with no alteration / modification of shock absorber component (unless specifically mentioned) or original vehicle shock absorber mount. No remote operated (electronic or cable) cabin adjustable shock absorbers permitted. No homemade / modified shock absorbers allowed.
- g) Aftermarket shock absorbers may change top mount (rod end only not reservoir / canister end) to the standard fitting as per model. Store-bought shock absorber adaptor mounts e.g. Rose type fitting to standard pin type permitted.
- h) Aftermarket Front struts or front strut inserts permitted for Holdens and must be fitted as per manufacturer's instructions.
  - For Bilstein strut inserts, the top part of the original strut shaft between the spring saddle and the shaft aperture may be removed and replaced by

welding on the supplied threaded collar. The insert is then fitted and held in place by the supplied threaded fitting on the replacement strut.

- For Koni strut inserts, the top part of the original strut shaft between the spring saddle and the shaft aperture may be removed, and a hole drilled in the bottom. The insert is then fitted and held in place by the supplied locking bolt at the bottom.
- i) A non-adjustable spreader bar is permitted for McPherson Strut type suspension towers. Maximum material 25mm x 25mm x 3mm RHS. Must be between towers only-
- j) Standard or aftermarket Camber and Castor adjusters are permitted -front suspension only.
- k) Lower control arms may be strengthened by the use of 1 only 300mm x 12mm solid rod stitch welded along each side of control arm.
- l) Independent rear suspension (**IRS**) is acceptable if optional for the vehicle. Strengthen/fabricate rear toe link using front end tie rod components and CHS is permitted for Ford AU IRS or Holden IRS where rear toe link is a standard component. IRS Control arms may be strengthened by the use of 40 x 3mm flat mid steel at each end (mounting points).
- m) [IRS adjustable camber permitted using OEM components for make/model without modification. Commodores from VT onwards may use 1 only eccentric \(offset\) bush on each side \(either inner or outer\) on the lower control arm to adjust camber.](#)
- n) **Commodores** - McPherson Strut suspension can have camber castor adjusters in the top of the Strut or aftermarket camber pins for bottom control arms not both.
- o) **Falcons EA onwards** - Camber pins and castor adjusters are permitted. Aftermarket camber pins and plates (no homemade plates) must be used. The measurement from the inside of the cross member to the centre of original bolt hole is 50mm. The camber plate has an elongated slot. The original bolt hole has to be in the centre of the elongated slot. Camber plate is to be welded to the cross member. A movement of 10mm left or right is allowed. Total measurement 60mm, (refer diagram). Hole only allowed with Camber Pin, otherwise to remain standard.

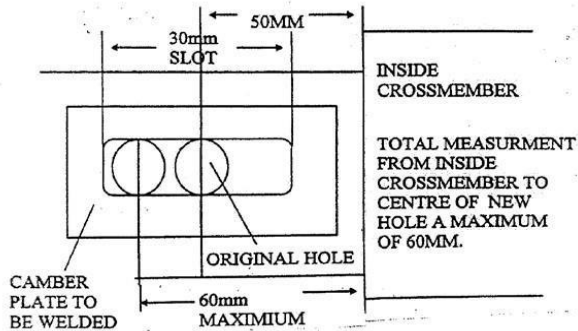

- p) Nolathane, Urethane etc. bushes can be used, but not solid steel/alloy bushes. Rubber / Nolathane spacer blocks ('spring rubbers') are permitted in coils.
- q) Spring retainers to stop coils falling out are allowed. After-market anti-sway bars allowed.
- r) Lowering or jacking by use of weight-jackers or adjusters not permitted.
- s) Wearable components such as: Ball Joints, Tie Rod Ends, Arm bushes, Universal Joints, Starter Motors, Alternators, and Water Pumps all may be replaced with aftermarket replacement items (store bought not homemade).
- t) Standard aftermarket suspension replacement components allowed but must be original length e.g. trailing arms.
- u) Panhard bar mounts may be strengthened using maximum 50mm x 50mm x 3mm angle iron but must remain in original position.

## 22) WHEELS/TYRES

- a) No racing tyres, no racing retreads, and no off-road rally tyres allowed. Tyres must meet minimum 60 durometer reading. Radial tyres only speed rating V maximum (e.g. W,Y,Z not permitted). All details are to be visible in OEM markings on tyre side walls, (e.g. 225/65 R15V or 215/70 R15H). Retread tyres must have the correct remoulder's speed rating etc.

- b) Rim size is optional up to and including 17" diameter. Cortina's can use up to 15" wheels with 5 stud conversion. **All four wheels to remain the same diameter on vehicle at any time**, no combinations of varying diameters permitted. Wheels must be in good condition and free from cracks. Standard manufactured steel wheels including aftermarket steel wheels permitted. Welded wheels optional. Mag or Alloy wheels may be used but must be of one-piece construction. Composite type wheels NOT acceptable (Composite means wheels that are made of different materials).
- c) Centre hole of all rims should match the Hub so that studs don't carry all the weight of the car. Wheel studs must be a minimum of 11mm. Cortina axles may be modified to strengthen flanges. Wheel weights not permitted. Wheel spacers permitted, maximum 10mm per wheel. Spacers must be a 'store bought' item not homemade. Suitable long wheel studs must be used with spacers.
- d) Tyre / Rim combination must not extend outside of the original bodyline of all wheel arch / guard areas on all vehicles. **Note-** The general ruling on this is taken from the top outside edge of the tyre/rim combination (not the bottom outside edge) in relation to the outermost point of the wheel arch/ guard'. Scrutineers are to use obvious discretion and judgment on each situation.

## 23) WHEEL ARCHES

No internal or external cutting of guards permitted. No flaring of guards.

## 24) BRAKES

Race cars must be fitted with effective brakes on all four wheels. No adjustable brake taps or similar permitted. Not necessary to lock up.

## 25) PEDALS

Commodore or Falcon pedal box to be used and mounted as close as practical to the original position. Accelerator pedal may be moved to the left to allow for clearance to foot protection plate. Pedals can be extended up to 75mm to suit shorter drivers.

## 26) STEERING

- a) Left-hand drive not permitted. Steering must remain in standard and sound condition Steering position to remain standard. Modifications are not permitted to any steering components unless specified.
- b) Power Steering optional provided it is as per production line for model. Late model cars mounting to Scrutineer's satisfaction. Standard pulleys must be used. Aftermarket power steering oil cooler permitted, (1) one only, must be mounted in engine bay.
- c) Original or sports type steel wheels approved. Wire spoke or wood rim steering wheels not permitted. Centre of steering wheel must be padded. Factory type thick centred wheels do not require padding.
- d) Steering column must pass through a steel loop 12mm thick, bolted or welded to the dash bar (loop not required if using a Rose joint). No chain or exhaust clamps permitted. No cutting or welding of steering components allowed, other than for fitting quick-release steering wheel.
- e) Quick-release steering wheels optional. Steering wheel quick-release hub to be professionally manufactured and to be made of aluminium or steel – no plastic. It is recommended that the retaining pin be integral to the hub.
- f) Rose joint permitted on top mounting only. Bottom of steering shaft to be firmly located at floor and in original position. A collapsible shaft must be used and the rose joint must be securely retained on the shaft with locking collars either side of the rose joint, with shaft recessed for grub screw to be retained – circlips not permitted. Must be mounted on roll cage cross bar, extension for rose joint to be made of roll cage pipe only.
- g) Aftermarket left side rack mount permitted for VT - VZ Commodore to replace standard rack mount.
- h) The use of professionally made after market steering column mounts as shown below is permitted. Mounts must be in original position and not to be used to offset steering position. Must be securely mounted to lower windscreen bar.



## 27) TRANSMISSION

- a) Ratios are optional but must be from same make or optional model.
- b) Standard factory gearbox must be used, but three (3), four (4) or five (5) speed gearboxes can be interchanged but must be from same parent manufacturer. Straight or split tail shafts may be used to suit gearboxes and differentials. Tail shafts are interchangeable i.e. Falcon to Falcon: Commodore to Commodore.
- c) Automatic transmission optional provided it is as per production line for make/model. OEM factory torque converter to be run in all automatics – not removed. No transmission ‘taps’ or similar allowed. Aftermarket automatic transmission oil cooler permitted (1) one only. Maximum size 350 x 300. If mounted in cabin area it **must** be fully shrouded including covering of all hoses, connections and lines. Cooler to be mounted off roll cage in as **low** as practicable point in cabin area with inlet / outlet pipes facing **away from driver**. All cabin hosing / piping to be restrained in such a way as to minimize ‘whipping’ of hoses upon separation from cooler outlets. All oil hose connections in cabin area are to have a minimum of 2 approved clamps for each join. Fan permitted on cooler.
- d) Race vehicles must have a minimum of two (2) forward and one (1) reverse gear. Gear lever (1 only) shall be rendered harmless by the use of a suitable knob, handle etc.
- e) A steel strap or chain is to be secured under the front of the tail shaft within 150mm to the rear of the front universal joint. Loop is to have a 50mm clearance below tail shaft. Materials to be a minimum 5/16" (5mm) chain or 5mm x 25mm strap.
- f) Neutral/inhibitor safety switches or brake pedal switches must be installed and working on all auto transmission cars.

## 28) DIFFERENTIAL

- a) Ratios may be altered if crown wheel and pinion only are changed. Differentials are interchangeable i.e. Falcon to Falcon, Commodore to Commodore. Differential must be from 4- and 6-cylinder models **only**. No V8 or aftermarket crown wheel and pinion.

- b) No offset mounting of diffs, trailing arms or control arms. No retrofit of vehicle mounts etc. to convert solid beam axle diff configuration to a factory IRS configuration. No retrofit of vehicle mounts etc. to convert IRS vehicle to solid beam axle diff configuration.
- c) There will be no quick-change diffs permitted. (forward or back)
- d) All diffs to be locked. Four (4) wheel drive / steer not permitted.
- e) Rear axle bearing collar rings to be tack welded to axle. Maximum two (2) tacks 5mm long, using a small diameter low hydrogen rod on low amperage. If axle is lost and it found that this has not been done, driver will be penalized. Exception: IRS (no axle bearing collar rings).

## **29) DIFF HAT PIVOT PIN STRENGTHENER**

- a) The purpose of this bracket is to strengthen the diff hat pivot pin only, NOT any other part/component of the diff hat or pan arm bar assembly.
- b) No welding or cutting or modifying on any part of the differential. No welding or cutting or modifying of original diff hat, diff hat pivot pin, diff hat pan arm bars and connecting assembly.
- c) Diff hat pivot strengthener must be of STEEL construction only. Diff hat pivot pin strengthener must only be attached by bolts to the ORIGINAL DIFF HAT LOCATION ONLY on diff housing. NO EXCEPTIONS.
- d) Longer mounting bolts must be used into diff housing to include the extra thickness of the material used in the bracket. (No original length bolts to be used). Mounting bolts to be loctited or equivalent firmly into place.
- e) Design of diff hat pivot pin strengthener must be of an open (skeletal) design, not an enclosed (bowl) design.

## 30) ENGINE (CARBURETED)

- a) 4- and 6-cylinder engines only. Rotary, Turbocharged, Supercharged or any other engines not permitted. No model built specifically for a 4-cylinder motor will be permitted to run a 6-cylinder motor.
- b) Early model motors and heads may come forward to a later model car. Late model motors may be used in earlier model cars, but in both cases engine mounting points must not be altered in any way (e.g. Holden to Holden, Ford to Ford). These motors must use a Carburettor.
- c) Holden's may use up to and including the 3.3 black motor. Holden 12 port Manifolds can be used on a 9 port Head.
- d) Fords may use up to and including the 4.1 alloy head cross flow motor.
- e) Engine capacity 274 ci, absolute maximum.
- f) Manufacturer's markings to remain on engine block castings.
- g) Engine position (EFI included) to remain standard as per model without modification. K-frames may be interchanged between some models (e.g. EA to EL) as long as K-frame bolts on to existing vehicle. No welding, cutting, drilling or modifying of or on K-frame to fit another model is permitted unless specifically mentioned.
- h) Engine must be mounted in original position without modification using solid engine mounts, or resilient engine mounts with minimum 6mm chain restraints. Aftermarket/commercially available encapsulated engine mounts (steel or alloy) permitted and do not require chains (eg 'Tuff mounts').
- i) Internal modifications to all facets of engine and head (includes carburettor) allowed, except the following:
  - No roller Rockers or Roller Tip Rockers.
  - No Roller Cam or Followers.
  - No Stroking (increase or decrease).
- j) Standard Distributor to be used without any modifications to fit. No performance enhancing types permitted.

- k)** Aftermarket standard equivalent/weight steel Flywheel and Clutch to be used - no lightening. Inspection cover optional. Hydraulic and cable Clutches are interchangeable.
- l)** Oil coolers permitted (1 off) for automatic gear boxes. Engine oil coolers permitted (1 off) if factory fitted on production base model – must be in engine bay only. No aftermarket auxiliary engine oil coolers permitted.
- m)** Crankshaft, Alternator, Power Steering and Water Pump Pulleys must remain standard as per model unless otherwise noted.
- n)** Factory Manifolds and Extractors accepted for model.
- o) Carburettor**
1. One single or dual throat carburettor.
  2. One single or dual throat manifold.
  3. No aftermarket carburettor or manifold to be used.
  4. Holley Carburettor not permitted.
  5. Aftermarket adjustable main jets not permitted.
  6. Maximum one (1) gasket per seal to be used.
  7. Cable may replace throttle linkages.
  8. Air cleaner optional, sports type can replace standard
- p)** NOTE: Carburettor to be OEM unless otherwise mentioned. Falcon/Cortina Weber engines to be of the maximum 'XE to XF Weber 34ADM' model with modifications/allowances and restrictions as mentioned within, and any other future notices.
- q)** Carburettor to remain externally visually standard, with an allowance to remove all choke and pollution equipment. Carburettor top may be milled down to, but not including, air cleaner mount flange only.
- r)** An extra return spring must be fitted to carburettor main throttle shaft. Carburettor can be changed to a Stromberg W.W. or Carter to all makes and models. Bowl must face in front direction.
- s)** Factory manifold must be used. Inlet manifold must not be cut, shortened, re-drilled or welded other than minor corrosion repair which may be checked by removal of carburetor and or manifold from engine. No re-drilling and or repositioning of any carburettor and / or manifold mounting posts or holes

permitted. An adaptor plate for carburettor can be used. Not to be used as a spacer. No more than 25mm maximum, to be bolted and must be removable.

## 31) ENGINE (FUEL INJECTED)

- a) **NOTE:** Specifications as mentioned within all other sections of this current **RSA Div. 4 Street Stocker Specification book 2023**, also relate to the rest of the build of the vehicle, and therefore must be noted, used and referenced where applicable in conjunction with the following EFI engine section -
- b) Engine must be mounted in original position without modification using solid engine mounts, or resilient engine mounts with minimum 6mm chain restraints. Aftermarket/commercially available encapsulated engine mounts (steel or alloy) permitted and do not require chains (eg 'Tuff mounts').

The following additional requirements apply to fitting Series 1, 2 and Ecotech engines into VE-VF Commodores:

- 1) The engine must be installed in the centre of the engine bay (side to side) and must not be offset to one side.
- 2) The engine must be positioned so the front of the harmonic balancer is 55mm +/- 5mm from front edge of engine cross member. The engine position will only be accepted within these reference points.
- 3) Engine mounts are to use the original mounting points on the engine and on the cross member. To be manufactured using either original engine plates or mounts or solid mounts (minimum 6mm thick plate or 3mm RHS). The cross member may be reinforced around the mounting point (single bolt hole) with 6 mm plate. The mounts must be manufactured to a professional standard.
- 4) All VE-VF Commodores are required to fit chains (minimum 6mm thick links) securely bolted from cross member to engine block on both sides of the engine.
- 5) The rear gearbox cross member can be solid or use the original gearbox cross member with minimum 3 mm angle iron welded off chassis to pick up the original gearbox cross member mounting points.

- 6) Tail shaft may be made up using VX manual front and VE rear section. All tail shaft modifications must be made by a professional. Tail shaft loops or flat plate (minimum 5mm x 25mm) across tail shaft hump are required within 150mm of front of tail shaft and within 150mm of the rear of the centre bearing.
  - 7) Any variations, queries or uncertainty should be referred to the RSA for clarification BEFORE the engine is fitted to the race car.
- c) EFI engines are to be **standard** with only modifications / additions and clarifications as mentioned in this current spec book and any other subsequent RSA approved and club notified revisions regarding EFI engines.
- d) FG Falcons and VE-VF Commodores must use RSA approved modified or after-market sumps to allow fitment of engines. The sump must provide for adequate clearance of the cross member. The sump capacity must not exceed 6 litres of oil (similar to standard sump).

## **ALL SUMPS TO BE APPROVED BY RSA BEFORE INSTALLATION**

- e) The **only** car and engine combinations permitted to use Fuel Injection (EFI) are as follows:

### **HOLDEN**

- 1) Commodore S1 and S2 3.8lt engines may be used in VN to Current models.  
Must use VN-VP computer and wiring loom, DFI module and coil pack.  
Valve sizes: Inlet 43.4mm Exhaust 37.8mm Throttle butterfly size 60mm  
Injector part numbers permitted: 0280 150 901 / 0280 150 960 / 0280 150 973 / 0280 150 917 / 0280 155 777
- 2) Commodore Ecotec 3.8lt engines may be used in VS to Current model only.  
Must use VN-VP computer, wiring loom, DFI module and coil pack. Ecotec engines must use VN/VR map sensor.  
Valve sizes: Inlet 45.5mm Exhaust 38.5mm Throttle butterfly size 64mm  
Injector part numbers permitted: 0280 150 901 / 0280 150 960 / 0280 150 973 / 0280 150 917 / 0280 155 777

- 3) Later model Commodore Ecotec II 3.8lt engines may be used in VT to Current model only.  
Must use VN-VP computer, wiring loom, DFI module and coil pack. Ecotec engines must use VN/VR map sensor.  
Valve sizes: Inlet 46.5mm Exhaust 38.5mm Throttle butterfly size 64mm  
Injector part numbers permitted: 0280 150 901 / 0280 150 960 / 0280 150 973 / 0280 150 917 / 0280 155 777

## FORD

All Ford EFI engines must use 1987-90 EA-EB pre-smartlock computer and standard or aftermarket standard equivalent distributor and coil.

EA-ED Falcons must use multipoint (log type) injection manifold.

EF-FG Falcons may use either multipoint (log type) or BBM (snail) injection manifold.

Early model motors and heads may come forward to a later model car – unless otherwise mentioned.

- 1) Falcon EA 3.9lt to ED 4.0lt engines may be used in EA to Current model  
Valve sizes: Inlet 47mm, Exhaust 39mm Throttle butterfly size 64mm  
Injector part numbers permitted: 0280 150 736 / 0280 150 790 / 0280 155 844
  - 2) Falcon EF 4.0lt to EL 4.0lt engines may be used in EF to Current model  
Valve sizes: Inlet 47mm, Exhaust 39mm Throttle butterfly size 64mm  
Injector part numbers permitted: 0280 150 736 / 0280 150 790 / 0280 155 844
  - 3) Falcon AU 4.0lt engines may be used in AU to Current models only.  
AU block, EA-EL head permitted – if used the head is to retain the original head valve sizes only.  
Valve sizes: Inlet 47mm, Exhaust 41mm Throttle butterfly size 64mm  
Injector part numbers permitted: 0280 150 736 / 0280 150 790 / 0280 155 844
- f) Fuel Injected Engines are permitted using the following restrictions:
- 1) All computers must be standard OEM, purchased and sealed by a RSA approved organization, **currently EFI Spares / CoolDrive Raymond Terrace NSW**. Owner supplied approved standard OEM computer for RSA testing and approved sealing permitted. No

approved or damaged seal etc. = no racing. Possible reinspection, re-testing and re-sealing of 'damaged' ECU will be the owner's responsibility including costs if applicable.

Computers / ECU units may be interchanged with a sealed replacement unit by a RSA / club official for a race meeting at any time. Failure to comply will result in minimum exclusion from that race meeting and other penalties may apply.

- 2) Any person found to have altered or added to any component of a computer / ECU will face a suspension of up to 2 years or as mentioned and determined under the applicable rules in the current (at point in time) version of Speedway Australia Racing Rules.
- 3) All ECUs are to be fitted and protected in such a way as to limit ECU damage and the sun / water / dirt deterioration of the ECU seals. Suitable encasing of the ECU is not only acceptable but recommended as long as ease of inspection and removal is still possible at any time.
- 4) **Standard** sized OEM injectors are to be used for make and model of engine or fuel injection system used. Inside diameter not to be increased or decreased.
- 5) Rev limiter must remain OEM and must not exceed OEM limit. The maximum revs attainable (peak revs) by engine may be checked at any time by a Scrutineer using any current (at point in time) method, technology and procedure as approved by the RSA.
- 6) All standard sensors except oxygen and cooling sensors must be fitted and operating.
- 7) Original diagnostic plug optional.
- 8) Electric fuel pumps must automatically shut off when engine stops running.
- 9) Base model engines only (i.e. No Turbocharged, Supercharged, VCT, XR6 or Tickford engines or heads). No forced induction.
- 10) Engines must remain externally visually standard with all components fitted unless otherwise mentioned. Exceptions are air conditioning equipment and air cleaner assembly.
- 11) Engine must be positioned in the engine bay with the rear face of the block in the same position as the original engine.
- 12) All casting marks must remain.
- 13) Crankshaft must be standard OEM for the engine. No offset grinding.
- 14) Conrods must be standard OEM for the engine. No lightening or polishing.
- 15) Pistons must not be machined or lightened. No additional flycuts/valve reliefs permitted, noting that standard Falcon pistons have a valve relief on the inlet side.

- 16) Rocker gear must remain standard OEM type for the engine.
- 17) Sump must be OEM and remain externally visually standard.
- 18) All pulleys must remain OEM for the engine block and all fan belts must remain the same type and profile as OEM for the engine block.  
Exception: EA-ED EFI may run the single serpentine belt configuration the same as EF-EL.
- 19) A minimum of 2 return springs must be fitted to control each butterfly shaft. OEM inbuilt type is acceptable.
- 20) Fuel pump must be passenger car type.
- 21) Fuel Tank must be professionally made with high pressure line and return line fitted into top or side of fuel tank. Breather pipe as per normal specifications.
- 22) A flexible fuel line section must be fitted within 75mm of fuel tank, and all fuel lines to be securely fixed in position. Barbed fittings of the correct size must be used in conjunction with screw type clamps when connecting flexible fuel line. (Genuine SAE R6 fittings and hose accepted).
- 23) Appropriately rated high pressure reinforced fuel Injection hose and fittings are to be used only. Securely fixed flexible fuel hose or OEM type 'Bundy' steel tubing may be used through the car or under the car.
- 24) Flywheels, pressure plates and clutch plates must remain OEM or standard replacement type.
- 25) Any engine component or ancillary item not specifically mentioned is to be OEM for the engine block or standard aftermarket equivalent.

**g) The following modifications **are permitted** for EFI engines:**

- 1) Camshafts may be non-OEM type.
- 2) Camshaft timing gear may be non-OEM type.
- 3) Valve springs may be non-OEM type.
- 4) Air cleaner and associated fittings may be non-OEM but must remain located within the engine bay. Protective wire gauze or air cleaner to be fitted over air intake to prevent entry of foreign objects to throttle body, and also to act as a flame trap.
- 5) Ignition / spark plug leads up to 8mm outside diameter.
- 6) Balancing of the engine / components permitted UNLESS components are specifically otherwise noted within.
- 7) 0.060" maximum oversize on standard bore.
- 8) 0.060" maximum facing off head surface.
- 9) Maximum 2-cylinder sleeves per engine block.

- 10) Aftermarket steel flywheels permitted on V6 Holden's. Minimum thickness 35.5. Not to be lightened.
- 11) Adjustable fuel pressure regulator – a manually adjustable, non-electronic fuel pressure regulator (1 of) and gauge only is permitted. To be securely mounted in the engine bay.
- 12) Commodore Ecotec engines may remove breather hose from throttle body. It is highly recommended to connect breather hose to a catch can to allow engine to breathe.

**h) The following are **not permitted** for EFI engines: **NO** -**

- 1) Porting or polishing of head /s or any inlet manifold component.
- 2) Head studs.
- 3) Lightened flywheels.
- 4) Angle facing of head and/or block surfaces.
- 5) Forced induction.
- 6) Removal of any balance shaft.
- 7) Performance type harmonic balancers.
- 8) Performance enhancing ignition systems
- 9) Modification to throttle body or butterfly.
- 10) Solid lifters.

## **32) ELECTRIC WATER PUMPS**

- a) An electric water pump is permitted but it is to be used only in conjunction with the existing standard water pump, pulley and belt configuration on the vehicle. Removal of those parts is not permitted.
- b) Electric water pump to be fitted in the engine bay or if fitted in the cabin area it must be behind the radiator (outlet side) in as low a position as practical and be mounted and suitably shrouded to prevent hot water / steam injury in case of hose or component failure. Approved hose clamps must be used (2 off recommended wherever possible) on each join.
- c) Fitment and shrouding of the electric water pump to be subject to the satisfaction of the scrutineer.

### 33) BELT GUIDES / TENSIONER

- a) The use of a belt guide is permitted, one (1) guide only. If running two or more belts, one guide in total is still only permitted. The one guide can be designed to encompass the multiple belts.
- b) The guide will be of no longer length than 70mm along the length of the belt. The one only guide can be welded / bolted to a secure location anywhere around the belt. The Guide may touch the belt.
- c) A roller type belt tensioner / idler pulley consisting of one roller tensioner per engine sourced from any make of vehicle or store-bought item may be fitted (no homemade pulleys). The tensioner may be fitted in any location on the motor near the belt with a suitable fixing bracket welded or bolted in place on the motor. This tensioner may be used in conjunction with the 'belt guide' as mentioned.
- d) Because of the wide range of belt configurations, no two designs would probably be the same, so it is up to the Scrutineers satisfaction that designs follow the above directives.

### 34) WINGS

- a) Wings are permitted on all vehicles as an option BUT only at the discretion of the host Club or track Promoter and as per track regulations. **NOTE:** No wings are permitted at any track for RSA nominated Title meetings.
- b) As the diversity of personal design and fitment of wings may vary and have not necessarily been able to be noted or covered within these specifications, contact club or RSA for approval before fitment if unsure of design.
- c) One (1) single left side mounted vertical roof plate wing only.
- d) Wing to be mounted parallel to edge of roof no further than 100mm in from roof edge. No off-set (diagonal) mounting of wing permitted. Steel / Aluminium only.
- e) No 'Sprint car' type or similar wing design assemblies permitted.  
No remote adjustable wings.

- f)** Maximum length 1465mm. Minimum length 735mm. Max thickness 1.8mm  
Maximum height 710mm (includes mounting brackets) and Minimum height is 355mm taken from the highest point of the roof.
- g)** If an RHS surround (optional) on wing is fitted - Maximum of 16mm x 1.6mm  
RHS material - mounted on sides and TOP edge only. Wing to roof side support  
arms (2 off) to be of a maximum 25mm x 25mm x 1.6 RHS material.
- h)** No other excessive strengthening of wing and supports permitted. Wing outline  
profile to stay within roof outline profile (no 'hangover' forward or back)
- i)** Wing and all connecting supports and brackets are to be securely and suitably  
mounted on the roof only and be to the Scrutineer's satisfaction.
- j)** Wing is recommended to be installed in such a way as to be removable for  
vehicle transporting purposes.

## **35) SPOILERS**

- a)** No body kits permitted, but rear spoilers may be fitted. There are many makes  
and models of spoilers, so any final interpretation of fitment will be up to the  
RSA Executive/Tech officer. If unsure consult before fitting.
- b)** Rear spoilers are allowed but must be polycarbonate, fiberglass or plastic only  
and of a mass-produced store-bought item. No steel, aluminium or homemade  
will be allowed. Maximum height must not to exceed 150mm from top of boot  
lid to uppermost point of spoiler.
- c)** Spoiler to not extend past the line of the rear quarter panels and must be firmly  
fixed. Hatchback spoiler not to exceed 150mm in height from lowest point of  
hatch.

## Appendix 1 – Limited Approvals 2022-23 season

The following optional specifications have been approved until the date of the 2023 AGM. Any permanent approval after that date is dependent on these specifications being passed at the 2023 AGM.

(None as of June 2023)