



Specifications

DIVISION 3

Junior Sedans

&

Standard 4-Cylinder Sedans

Publication Date:
August 2024

RSA Titles Policy

- On a state title event date for a RSA division, no race car registered for that division may race or practice at another venue on the same date using a logbook for the division that is holding the title.
- If a state title event is CANCELLED or POSTPONED for any reason and re-scheduled for a later date, the above restriction does not apply to the re-scheduled date (i.e. if the title event moves to another date, race cars registered for that division may race or practice at another venue on the re-scheduled date using a logbook for the division that is holding the title).
- Dual-registered race cars may race or practice using a logbook for a division that is not holding a title on the same day.
- Roof numbers may be changed to avoid duplicate numbers, car numbers must be displayed on front sun visor and rear taillights/ boot lid - minimum height 75mm.

RSA DIV 3 JUNIOR SEDANS & STANDARD 4 CYLINDER SEDANS SPECIFICATIONS

INTRODUCTION

- a) Racing Sedans Australia shall direct the enforcement of these specifications in every aspect. The RSA Executive Committee in consultation with the RSA Junior Sedans and RSA Standard 4 Cylinder Sedans Chief Technical Officers and Technical Advisor/s shall together be the authority for the interpretation of the specifications contained within and any further amendment, clarification, alteration or addition.
- b) Any amendment, clarification, alteration or addition of, or to these specifications will be sent to all RSA clubs (electronic / post) who shall then pass on the relevant information to their competitors and membership as required.
- c) This specification book supersedes all others, and no reference is to be taken from any previous books regardless of their contents. Any amendment or clarification will be sent to all clubs (electronic or post) who in turn will notify all their competitors/members.
- d) DIVISION 3 – JUNIOR SEDANS & STANDARD 4 CYLINDER SEDANS - **NO CONTACT PERMITTED**. Direction of racing will be anti-clockwise only.
- e) **NOTE:** *This book is to be read and referenced in its entirety. Whilst every effort has been made to have all relevant information pertaining to all issues contained in one area, paragraph or page of this book for quick reference and guidance, it may not have always been practical, possible or achievable for that to have had occurred.*

The contents of this book may not be copied or reproduced in any way without the written authority of Racing Sedans Australia Incorporated.

Table of Contents

JUNIOR DRIVERS	7
1) SAFETY STANDARDS.....	8
2) IDENTIFICATION NUMBERS	9
3) INSTALLATION OF DRIVER RESTRAINT SYSTEM.....	10
3.1) Seats	10
3.2) Seat Belts	11
3.3) Seat Belt Mountings	11
3.4) Seat Belt Installation Guide	11
4) WINDOW NET	13
5) BATTERY	14
6) ELECTRICAL WIRING.....	14
7) MIRRORS / CAMERAS / TRANCEIVERS.....	14
8) STARTER MOTOR	14
9) PEDALS	14
10) BODIES	15
11) BODY PANELS.....	17
12) FIREWALL	17
13) RUB RAILS.....	17
14) BUMPERS	18
15) ROLL CAGE	19
16) ANTI-SPEAR PLATE / FOOT PROTECTION.....	27
17) COOLING SYSTEM	29
18) EXHAUST	29
19) FUEL TANK.....	29
20) FUEL	31
21) SUSPENSION	32
22) WHEELS.....	32
23) TYRES	33
23) BRAKES.....	33
24) STEERING	33
25) TRANSMISSION	34
26) DIFFERENTIAL.....	34
27) ENGINES.....	35
27.1) Carburetted engines.....	35
27.2) Fuel Injected engines.....	36
28) BODY KIT AND SPOILER.....	38
Appendix 1 – Limited Approvals 2024-25 season.....	39

INTERPRETATION

- a) Specifications listed in this book are meant as a guide only to building race cars unless otherwise specified. **If "IT" is not mentioned in this book, enquire beforehand for clarification and / or possible approval.**
- b) Before constructing any race vehicle, or adding any part, panel or component thereof of unusual, unconventional or unknown design, full details are to be submitted in writing to the RSA. These submissions are to be with supporting documentation of the issue/s and come via your club to the RSA secretary for processing. A written response will be provided, and if approved, the letter of approval is to be attached to the car's logbook.

Note: It may not always be possible for RSA Committee persons and / or Tech Advisors / Officers to provide an immediate verbal or written response to queries relating to specifications.
- c) Prime consideration must be given where any doubt exists, to safety of Drivers, Crew, Officials and Spectators.
- d) It is recommended, whenever possible, that all race cars under construction be inspected by the licensed Club Scrutineer before painting.
- e) All race cars are subject to engine checks and general measurement at any time at the discretion of the Chief Steward, Technical Officer or Chief Scrutineer. Any question of legality of a race car, or eligibility of a race driver, must be settled before the commencement of a race meeting.
- f) Notwithstanding anything contained in these specifications or any other Supplementary Regulations that have been approved by Racing Sedans Australia Inc, the Scrutineer shall have the right to exclude any race car if it is not track worthy, fails to meet specifications in relation to safety or performance advantage, could become a danger to other competitors or the public, or is not constructed in an acceptable manner.
- g) The Scrutineer will make a full report in the car's Logbook of items not complying with the current specifications for the division. All entries in Logbooks for repairs must be completed prior to the next race meeting unless otherwise stated, or the car may be excluded from the event.
- h) All material sizes mentioned in this book are a minimum unless a maximum is stated. Any Part, Panel or Component not specifically mentioned to be modified must remain standard as per production base model.
- i) Ignorance of Speedway Australia Racing Rules and Regulations and this RSA Specification book and notices shall be deemed as no defence in regard to breaches and/or appeals of same.
- j) Race cars must maintain a neat and presentable appearance, so as not to bring disgrace to the Association. All body panels, bumpers, exhaust systems, etc., must be securely mounted. Any driver who continually loses components on the racetrack will be liable to a fine and/or suspension.
- k) All cars are to be built and repaired to a high standard. All material used is to be of high quality. No bolts/rivets/screws or holes of any sort are to be put in any structural tubing in the roll cage cabin area.
- l) Race cars, when presented for scrutineering, must be in full race condition (i.e. tyres to be used for racing, battery secured, helmet, full race clothing, bonnet and boot may be removed for ease of scrutineering).
- m) Any driver who continually loses components on the racetrack will be liable to a fine and/or suspension.
- n) It is the responsibility of all drivers to ensure their race cars have all sharp protrusions removed when presenting them for any race. The Scrutineer may at any time, direct a driver to remove sharp protrusions, and this must be carried out before entering the track.

- o) Car registration (green sheeting) and payment and issue of an annual / seasonal RSA logbook are required before competition. **Registration of an RSA Vehicle cannot be made by a person under the age of 18 years.**
- p) **PASSENGERS** Where state laws allow. Standard 4 Cylinder Sedans **excluding Junior Sedans** are allowed to carry a passenger for either promotional events or race events.
- 1) Cars must be daylighted by an authorised RSA Scrutineer through the approved process
 - 2) All safety requirements set out for driver safety must be mirrored to the passenger side. i.e. NASCAR Bars, Head Plate, Windscreen Mesh, Race Seat, Seat Belts, seat belt mounts etc.
 - 3) Anyone travelling in the car as a passenger must hold a Speedway Australia Competitors license or Day License for the appropriate division.
- q) It is the driver's responsibility to make sure that his/ her car and all internal and external engine components meet the specifications of this Division. Pre-race and post-race vehicle scrutineering inspections may be performed at any race meeting, including state and national titles. If any car fails the after-race specification inspection the driver will be fined / suspended and / or disqualified from the event under Speedway Australia's Racing Rules & Regulations.

r) **RSA head gasket refund policy:**

If the vehicle is found to comply with RSA specifications for the division after post-race scrutineering the RSA will either:

- Directly pay for OEM or standard after-market equivalent parts from an RSA nominated supplier, or
- Provide a refund that is equivalent to the RSA's cost for supplying replacement parts.

NO REFUNDS will be paid for any vehicle that is found to be in breach of RSA Specifications for the division.

- s) Vehicles may have fuel checked at any time during the course of any race meeting including state and/or National titles.
- t) Any driver found with any debris in cabin, boot or pockets, etc. (i.e.: broken glass, bolts, tools etc.) will be refused race clearance to enter the track until the offending items are removed.
- u) Long hair must be fully contained within suit. No cigarettes / lighters or similar allowed on or used by driver whilst in the race car and / or to track pit requirements. No asthma puffers allowed on driver whilst in the race car. Jewellery that could cause injury (e.g. dangling earrings) is not to be worn.
- v) Drink bottles (plastic) permitted – maximum size 2 litres. The drink bottle must be suitably and firmly mounted behind driver and to be to the Scrutineer's satisfaction.
- w) **NOTE:** RSA will not accept, recommend, or endorse any 'homemade' modifications / alterations to any suspension component/s or to any other OEM vehicle parts. Any fabrication / alteration allowable within these specifications to these items is to be performed only by persons who are certified specialists in their field of expertise in regard to modifications / repairs to the respectively noted equipment.
- x) RSA Inc. reserves the right to impound and inspect any race car at any time; this may include the removal of any engine for inspection and including the downloading of any information via relevant means if applicable. Cars can be selected at random and ordered to the impound area for dismantling. The Owner and/or Driver of the car must deliver them immediately upon request and supply the necessary manpower and hand tools to accomplish dismantling. Only 2 x persons actually involved in dismantling the car will be

allowed in the immediate area of a vehicle being checked. Any persons not having cars in the impounded area, and gaining entry without authorisation, will be ejected.

JUNIOR DRIVERS

- a. Drivers Age - Junior Licences are issued to a Driver 10 years of age, and under 16 years of age, at the time of applying for their Licence. **All junior competition licences expire on the day prior to the competitor's 17th birthday. All tracks must always have a recognised RSA junior trainer present while junior racing is being conducted on any NSW and ACT tracks.** RSA Junior Trainers are accredited via the NSW/ACT Junior Trainers Accreditation Course as it has been proven an excellent package for NSW/ACT Junior Drivers for many years.
- b. No Junior competitor will receive prize money.
- c. Junior Sedan Drivers in their first 2 seasons of racing to be known as New Stars, junior sedan drivers from their 3rd season onwards to be known as All stars. Junior sedan drivers to be known as all stars and new stars, the latter only if numbers permit.
- d. Junior Sedan Racing will be conducted under the current rules of Racing Sedans Australia to Licence, Register and Train their Juniors.
- e. **Conduct Book-** As of 1st July 2023 Conduct books are no longer required. Any conduct entries will be written in the Logbook. Logbooks to be kept by secretary for the duration of the race meeting.
- f. All junior drivers must be trained by an accredited RSA Junior Trainer, Junior driver training application form must be filled out and signed by the parent/guardian and junior trainer before he or she can enter any racetrack in NSW and ACT. A copy of the application form to be sent to the RSA secretary once training is done for record purposes.
- g. Recognition of Prior Learning for interstate competitors so that they do not need to complete the NSW Junior Driver Training Program prior to racing on NSW and ACT tracks. The minimum requirement to avoid the training is six log book entries of completed race meetings and/or a letter from their club stating they are competent and are free of all infringements.
- h. **Code of Conduct**
 - **TO BE WELL PRESENTED WHEN IN PUBLIC**
 - Always be well spoken.
 - Always sign autographs when asked.
 - NEVER wear a race suit pulled down and tied around your waist when in public.
 - Respect all other competitors.
 - The USE OF MOBILE PHONES or ANY OTHER media to INTIMIDATE or HARASS any other competitor WILL receive 12 months suspension.
 - Any swearing from any drivers, parents and/or pit-crew WILL NOT be tolerated. Offenders WILL be excluded from the race meeting and this will be recorded in the conduct book of the driver. REPEAT OFFENDERS WILL FACE FURTHER PENALTIES.

1) SAFETY STANDARDS

Note: These are the minimum only safety standards for racing apparel of which may be subject to change at any time. Refer to your local club and/or www.speedwayaustralia.org for current up to date regulations and notification of any changes. At the time of publication, the following standards were applicable (copied from Part 16 of Speedway Australia Racing Rules & Regulations, v.24/25.1 version):

APPLICABLE LICENCE CATEGORIES

- **A** All Sedan Divisions
- **B** All Divisions
- **JD** Junior Competitors except Jr F500's

16.1) Race Suit

Minimum standard of a 1 piece complying with either SFI 3.2A/1, FIA 8856-2000, FIA 8856-2018 or a higher standard of apparel.

16.2) Boots

Comply with SFI 3.3, FIA 8856-2000 or FIA 8856-2018. Socks must comply with SFI 3.3, FIA 8856-2000 or FIA 8856-2018.

16.3) Balaclavas

Comply with SFI 3.3, FIA 8856-2000 or FIA 8856-2018 and must be worn

16.4) Gloves

Comply with SFI 3.3, FIA 8856-2000 or FIA 8856-2018. It is recommended they are the Gauntlet style glove, and they must not be modified in any way.

16.5) Underwear

Must be worn and comply with SFI 3.3, FIA 8856-2000 or FIA 8856-2018, must be long sleeved, long legged and must have a neck collar. Drivers must only wear cotton under-garments (e.g., no synthetic boxer shorts), and no under wires on bras. No synthetic attire and no jewellery to be worn by a competitor whilst competing.

16.6) Helmets

Tozuda head impact indicators are optional.

Note: RSA recommendation only and is not part of the SA safety rules

Full faced and comply with one of the following:-

- 1) Snell SA2025 (to be introduced October 1st 2025)
- 2) Snell SA2020
- 3) Snell SA2015 (Note: Snell SA2015 Standard Helmets cannot be used after July 1st 2026)
- 4) FIA 8858-2010
- 5) FIA 8859-2015
- 6) FIA 8860-2010
- 7) FIA 8860-2018

For JD (Junior Divisions) only, the following helmets are also approved for use.

- 1) SFI 24.1
- 2) CMR2016
- 3) CMS2016

NOTE: All BS 6658-85 Type A/FR, AS/NZS 1698:2006 or UN ECE 22.05 standard Helmets cannot be used after 30 June 2024.

16.7) Horse Collar

Compulsory if Driver is not using a Head and Neck Restraint. Must comply with SFI 3.3.

16.8) Head and Neck Restraint

Recommended but not mandatory. If worn a Head and Neck Restraint must conform with FIA or SFI 38.1.

Please note that SFI Spec 38.1 Head & Neck restraints must have an in-date compliance sticker on them. The SFI 38.1 Spec requires them to be re-certified every five years. Competitors and officials please take time to check the dates on all Head and Neck Restraints to ensure compliance with these rules.

- HANS Device Recertification Revolution Racegear www.revolutionracegear.com.au
- Safety Solutions / Simpson Hybrid + variants & R3 Frontal Head Restraints Simpson Safety Equipment Australia www.simpsonraceproducts.com.au

16.9) Arm Restraints

Arm restraints must be worn in all classes where a window net is not fitted. Must comply with SFI 3.3 or FIA. Where a window net is used, it must comply with SFI 27.1 or FIA J253.11 and comply with expiry dates/replacement periods.

2) IDENTIFICATION NUMBERS

- a) All race cars must carry the correct identification number as is issued by their club. The numbers must be displayed on BOTH front doors, rear doors or quarter panels. Numbers on doors are to be a minimum height of 40cm high x 7 cm wide strokes, on rear quarter panels minimum 30cm high x 7cm wide strokes, in a contrasting colour and easily read by officials. Club prefix to be minimum height of 10cm high x 2 cm wide strokes. club prefix optional. IE: Grafton = GCSC.
- b) Drivers will use upright roof numbers of no more than 16G material, 300mm x 300mm in size - Number must be **white on black background**.
- c) Visiting drivers with conflicting car numbers will alter their roof numbers as notified when it is required for lap scoring purposes. Failure to comply will be dealt with by the Chief Steward.
- d) Car number must also be displayed on windscreen visor and rear taillight/Boot lid. Minimum height 75mm.
- e) Drivers' name is to be placed above right-hand front door or on sun visor minimum height 7cm.
- f) Current RSA registration / logbook decal must be affixed to the roll cage / cabin area within easy view for verification.

3) INSTALLATION OF DRIVER RESTRAINT SYSTEM

In order for the driver restraint system to be fully effective, considerable thought must be given to the location of mounting points and to proper installation in accordance with the product manufacturers' installation instructions. Many installations comply only with the letter of the rule with no understanding of the purpose, and although effective, to some degree, may cause needless injury to the driver.

3.1) Seats

- a) A purpose-built, one piece, Steel or Aluminium bucket type seat and headrest must be used. Seats may be padded and covered with a fire-resistant type material, the covering being securely attached - maximum thickness 50mm. NO fiberglass or plastic seats allowed.
- b) Minimum of 50mm clearance between helmet and head plate.
- c) All seats should be mounted as per manufacturer's installation instructions.
- d) Seats must be either:
 - mounted directly to the roll cage or seat frame of roll cage material (minimum 38mm OD x 3mm WT CHS) and/or 50mm x 50mm x 3mm angle iron or stronger or,
 - mounted to the roll cage or seat frame of roll cage material (minimum 38mm OD x 3mm WT CHS) and/or 50mm x 50mm x 3mm angle iron or stronger using the manufacturer's seat mounts for the seat being used.
- e) The seat must be suitably supported by a minimum of 50mm backing plate or washers (to prevent bolts pulling through seat). A minimum of 4 x 8mm bolts must be used - 2 upper (e.g. in seat back) and 2 lower (e.g. in seat base or sides). All seat bolts must be of cup-head design.
- f) All cut-outs for seat belts must be suitably grommeted. No sharp protrusions allowed.
- g) Side supports to be a minimum of 50mm on all seats at thighs and torso areas. Seat is to be a correct fit for driver.
- h) Side head/shoulder support restraints optional – manufacturer's recommendation on fitment.
- i) Head supports are mandatory. It is to prevent side movement of the head. Supports to be fitted to both sides of seat. Head rest must be at least 100mm wide. (Cover with suitable material optional).
- j) The centre line of seat, steering column and pedals to remain as per O.E.M for make and model measured at waist line.

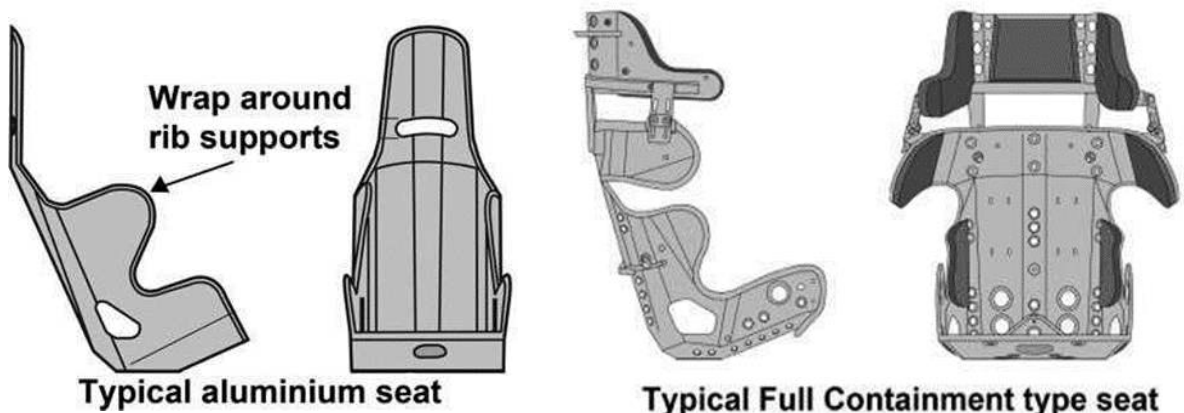

3.2) Seat Belts

- k) All race cars must be fitted with a 5 or 6 mounting point racing harness of the lever latch style, which must be certified by an authoritative body (such as SFI) and must conform to all of their policies including fitment and care/maintenance. Any worn, frayed, rotten or weld spotted holed seat belts are not acceptable, and race cars will not be allowed to enter the track until the seat belts are replaced.
- l) Seat belts must be no older than 2 years from the date of manufacture. Date of manufacture and/or expiry date must be clearly marked on a manufacturer-fitted identification tag.
- m) Belts, including crotch strap must be a minimum width of 50mm (2 inch).
- n) All seat belts must be mounted in such a manner to allow their removal between race meetings or when working on the car.

3.3) Seat Belt Mountings

- o) Because of the difference (often vast) in competition race cars and size of drivers, a standard method of mounting is impractical. Good judgment and common sense are needed. The lap belt should be positioned so that it rides across the solid pelvic area and not the soft stomach area or down on the thighs. Seat belts must be mounted to roll cage. Mounting brackets must be welded to roll cage or roll cage cross braces only. Mountings to be equivalent or stronger than roll cage material or 50mm x 50mm x 3mm angle iron. Any race car found with bolts through seat belt webbing will be immediately given an order to replace seat belts. Rear anchorage must be mounted so as to prevent side movement by harness. Scrutineer may require the fitting of a rear harness loop.
- p) MINIMUM 10mm bolts to be used.

3.4) Seat Belt Installation Guide

- q) The purpose of this guide is to provide race car drivers, owners and mechanics with additional information on seatbelt installation for upright seats (up to 25° recline seat back angle). This guide is for informational purposes only.

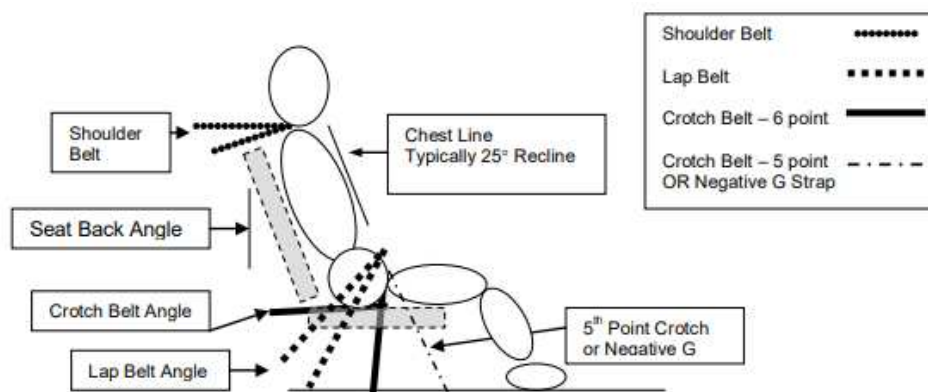

SHOULDER BELTS

Shoulder Belt Angle: 0 to -20° (-10° optimum) from horizontal

- Clear passage of webbing from top of shoulder (or head and neck restraint) back to the harness bar or mounting point without any interference of the seat openings
- Belts should be as short as possible back to the mounting points

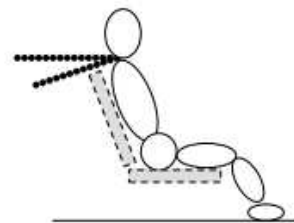

LAP BELTS

Lap Belt Angle: -45° to -80° from the horizontal

- Belt should ride within the curvature of the pelvic bone preferably just below the iliac crest
- There should be clear passage through the seat opening without webbing being corded or binding on edges of seat openings with a direct path to the mounting point
- The webbing should not ride against any hardware such as seat mounting brackets, bolts, or tabs
- Lap belt adjusters should be clear of the seat openings. Pull-up adjusters if outside the seat opening should be a minimum of 2" below the opening when the lap belt is tightened

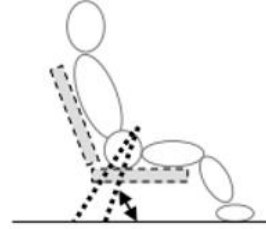

- Belts to the mounting point should be as short as possible mounted beside the seat and never behind the seat
- Lap belt should be allowed to pivot freely at the mounting point
- Webbing should be allowed to pull on hardware in plane (straight)

Position of the Cam Lock or Latch and Link

- Centered on the body 1 to 2 inches below the belly button when all belts are tightened

CROTCH BELT – 5-POINT

Sports Car “Shell Type Seat” and aluminum seats with single crotch belt hole forward of the inside seat back from 11 to 13 inches:

- Crotch Belt Angle: Chest line to 20° through the hole
- Crotch Belt should never wrap around the front of the seat – there should be a pass through
- Crotch belt is used only to maintain position of the lap belt

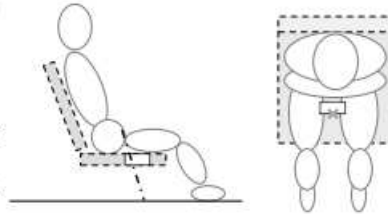

CROTCH BELT – 6-POINT

Sports Car “Shell Type Seat” and aluminum seats with single crotch belt hole forward of the inside seat back from 10 to 12 inches: *(NOTE: Seats with a single hole positioned more than 12 inches from the inside seat back are designed for 5 point belt installations and may not be as effective for 6-point installations):*

- Crotch Belt Angle: -20° (2” rearward) through the hole
- Two separate anchors 4 to 6 inches apart (x)

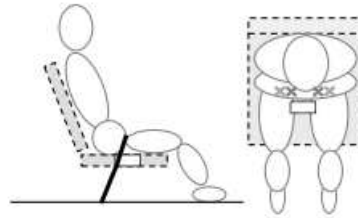

Containment Seats with Crotch belt mounting directly to seat bottom OR through holes provided at the back of the seat bottom: *(Driver is sitting on the Crotch belts)*

- Crotch Belt Angle -10° to -20° from the perpendicular just in front of the crotch with anchors 4 to 6 inches apart (x)

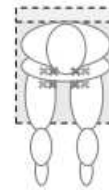
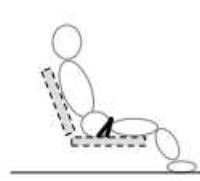

OR

- Crotch Belt Angle Horizontal rearward to under the butt or to the back of the seat (x)

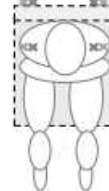

Option (typically for single-seat wide cockpits):
Crotch Belt mounting to the front side of the outboard lap anchors. (Option not illustrated)

Considerations:

- Routing of crotch belts should have a clear and unobstructed path to the mounting point

4) WINDOW NET

Must be mirrored on passenger side bar work if passenger seat fitted.

The use of an SFI approved window net is mandatory. It must comply with SFI 27.1 or FIA J253.11 and comply with expiry dates/replacement periods (Speedway Australia rule).

- All race cars must be fitted with a propriety type (i.e. a well-made, either from a race wear manufacturer or made by an upholsterer) web style window net (i.e. no string nets and no steel mesh). The window net should, as near as practicable, cover the drivers' side window opening. Triangular window nets are not permitted. Maximum size of holes to be 75mm x 75mm.
- All window net mounting brackets must remain inside window and door frames. The purpose of a window net is to stop the head or arms coming outside of the car in an accident or roll-over. Window net must be easy to remove in case of an accident. Window net MUST be hinged from the bottom.
- Must be securely mounted top & bottom to avoid coming loose in an incident.
- Window net must be mounted to the roll cage using brackets, using minimum of 3mm steel plates and a minimum of 6mm steel or 10mm aluminium rods, and mounted so that it cannot be pushed outwards.
- Top mounting rod must be manually removable (i.e. without using tools). Examples of this are: spring-loaded fitting, seat belt style fitting, R clips etc. If using a spring-loaded fitting, it must have sufficient tension to avoid it coming loose in the event of an impact.
- Ocky straps not permitted.

5) BATTERY

- a) Battery must be securely fastened in a steel frame in the cabin area. After market weld on/bolt on battery bracket (e.g. Kenco weld on or bolt on steel battery box clamp) permitted. No plastic bridges.
- b) All batteries (sealed batteries included) must have an effective rubber cover placed over the top to prevent acid spilling in the event of a roll-over. Rubber grommets must be fitted where battery cable passes through metal firewalls.
- c) A highlighted blue triangle is to be placed on outside of car body to show battery location. A white bordered blue triangle permitted for contrast on blue or similar coloured cars. Maximum battery size N70zz.

6) ELECTRICAL WIRING

- a) All switches to be grouped together within easy reach of driver with seat belts fastened and clearly marked on/off.
- b) A 'kill switch' must be fitted outside the windscreen in the centre of the cowl panel or on the front of roll cage windscreen centre bar to control all electrical circuits and must be clearly marked on/off in a contrasting and distinctive colour. Dipper switches may be used and it is highly recommended that a 'fairy light' be used to indicate when power is on/off. No other lighting to be fixed to any other body panels or external of vehicle. Electrical wiring must be grommeted where it passes through firewalls etc. and taped to prevent chaffing.

7) MIRRORS / CAMERAS / TRANCEIVERS

- a) Mirrors or similar not permitted. Small electronic recording devices (cameras) are permitted on vehicles but need to be securely mounted within the cabin area. Various configurations and designs may need prior approval before fitment. **No** electronic device / screen or similar, capable of receiving live transmission from rear, side or front facing cameras **to driver** permitted in any shape or form whatsoever. Penalties will apply. One-way steward to driver communication devices (raceceivers) and lap scoring transponders are permitted. All other radio or similar telemetry to or from a car is not permitted.

8) STARTER MOTOR

- a) At the commencement of the race meeting, car must be capable of starting by an installed starter motor.

9) PEDALS

- a) Standard pedal box to be used and mounted as close as practical to the original position.
- b) Accelerator pedal may be moved to the left to allow for clearance to foot protection plate.
- c) Additional options permitted to suit shorter drivers:
 - Pedals may be extended by up to 75mm.
 - A second set of floor-mounted pedals may be installed which operate the standard pedals via connecting rods.
 - Accelerator pedal may be moved to line up with either pedal extensions or second pedal set.

- Other options are permitted only if approved by the RSA Technical Committee. Letter of approval to be attached to the car's log book.

d) Aftermarket aluminium pedal pads permitted. Must be securely attached. Some examples shown below:



10) BODIES

- A body change is using the same model shell. Car must be re-green sheeted and log book marked "body change".
- Sedans, Hatchbacks and coupe only permitted. No mid mount or rear mount motors permitted. No full chassis Cars, Convertibles, Utilities or Panel Vans. Body of vehicle must be in sound condition. All glass external mirrors, grills door handles, ornaments, bull bars, tow bar, helper springs and all inflammable material to be completely removed together with manufacturer's fuel tank.
- Lights and body apertures must be filled with 1.6mm sheet steel, aluminium (maximum) body material, fibreglass or suitable plastic. Doors must be securely bolted or welded. ALL inner panels are to remain intact. Original front sub-frames and inner guards must remain in place, except that; the section forward of the leading edge of both front tyres may be removed, unless they constitute suspension or engine mounting points. Radiator support panelling may be removed if radiator is not in the engine bay.
- No car model can be newer than 8 years old. All vehicles must have a minimum seating capacity of four (4) people.
- Bonnets to be securely fastened. Four bonnet pins if steel, five for fibreglass/aluminium, to be 10mm minimum to 15mm maximum mild steel or approved equivalent. Bonnet pins to be in the bonnet, not sides or mudguards. No mounting pins inside of panels, i.e. mud guards. Bonnet lock pins 3mm to 6mm maximum. Heavy duty large reinforcing washers (min. 50mm OD) to be fitted to all bonnet holes on fibreglass bonnet. Similarly, boot lid to be securely fitted, using pins and large washers as for bonnet. The removable boot lid to be securely mounted in four points.
- Hinged bonnet and boot lid permitted, using minimum of two pins. Skeletonizing not permitted on hinged panels within 50mm of hinges. The hinged panel must be welded or bolted to the bonnet or boot. DOORS must be securely bolted or welded. BOOTS to be pinned. Bonnets if hinged, to be pinned on two (2) front corners, if not hinged to be pinned on all four (4) corners. If fibreglass bonnet is used, it is to be pinned on five (5) points – three (3) at front and two (2) at rear. NO bonnet pins allowed in sides of mudguards, side panelling or side of body. NO Bolts, nuts or chains.
- The front (east/west) sub-frame section may be replaced and fabricated with 40mm X 40mm X 3mm RHS only and may be attached to the optional front bar work alongside original sub-frame forward from roll

cage. The front engine mount support to be re-attached to the fabricated 40mm X 40mm steel tube and must remain in the original OEM position for the model being used.

- h) If the radiator is not in the engine bay, the radiator support panel may be removed and replaced with maximum 38mm x 3mm RHS. Brackets for bonnet pins may be attached to this barwork.
- i) A protective mesh must be fitted to the driver’s side of the windscreen. Mesh to be up to maximum 5mm thick x 50mm x 50mm or 50mm x 75mm maximum. There must be a clear vision area in front of the driver of at least 200mm. Name plate may run width of front windscreen, maximum depth at centre of windscreen 200mm. Windscreen mesh may be welded to roll cage or attached to roll cage using metal clamps, minimum 4 clamps (2 on each side) for single-side mesh or minimum 6 clamps (2 on each vertical roll cage bar) for full windscreen mesh in divisions which allow this option for 2-seaters. **Must be mirrored on passenger side bar work if passenger seat fitted. ***only applies to standard 4-cylinder sedans.**
- j) Additional windscreen mesh option for 2-seaters:

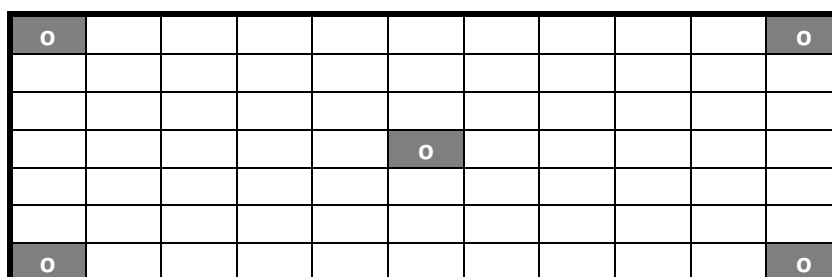

A one-piece removable windscreen mesh covering full width of windscreen and attached to roll cage by 5 pins and clips or snap rings is permitted as an option:

- Outside border: Minimum 5mm steel rod shaped to fit into the original windscreen channel on the car body.
 - Internal mesh: 3mm to 5mm, 50mm x 50mm or 50mm x 75mm steel mesh.
 - Metal plates: 5 x minimum 3mm steel plates fully covering one square of the mesh to be welded in – one in each corner and one in the centre as shown.
 - Pins: 5 x 10mm to 15mm steel pins to be welded to roll cage at one end and go through the metal plates to hold the mesh in place with clips or snap rings.
 - R-clips or snap rings: 5 x minimum 3mm R-clips or snap rings in – one in each corner and one in the centre.
- k) Passengers side of front windscreen to be fully open.
 - l) Name plate may be full width of windscreen. Dash may be removed, providing it does not weaken the body.
 - m) No TEK screws or self-tappers to be used in construction.
 - n) No added weight or ballast allowed.
 - o) Side mirror frame and/or front and rear quarter window frame (if fitted) may be filled in only – no partial or full fill in of any other side / front or rear windows permitted unless noted otherwise. Diagram below.

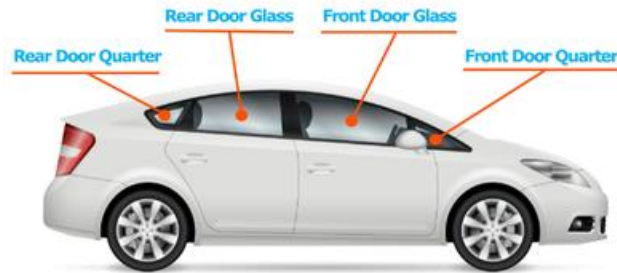

- p) If roof is removed during race car construction (e.g. to install roll cage), it must be fully welded (inside and out) when it is reattached. Additional reinforcing plates across joins are recommended.

11) BODY PANELS

- a) The only panels which may be replaced with fibreglass, aluminium or steel replica panels are bonnet, boot, front guards and doors. Replacement panels must be securely fastened; No TEK or self-tapping screws permitted.
- b) No skeletonising is permitted with the exception of all doors, bonnets and boots. If door has been skeletonised to run NASCAR type bar work, must have window welded in at least three (3) place 25 mm long (minimum) or removed Door frames and skins may be removed.
- c) A steel mesh grill may be used; maximum thickness 5 mm steel x 50 mm x 50 mm or 50 mm x 75 mm.
- d) NO TEK Screws or Self tappers to be used in construction.
- e) To assist with appearance of car, the rear quarter panels may be covered with fibreglass replica panels, securely attached to steel panels. Presentation of vehicle must be of a high standard.
- f) Open bonnet scoops not permitted. No part of the floor pan can be removed, including the wheel arches. The boot floor may be removed. If the boot floor is retained a hole 150mm x 150mm under the fuel tank is permitted. All other panels such as rear parcel shelf and fire walls must remain.
- g) Modification to front and rear firewalls, rear parcel shelf floor and engine tunnel not permitted.

12) FIREWALL

- a) Drivers must be isolated from mechanical, fuel, electrical and exhaust components by firewalls of minimum 0.9mm steel or aluminium. Standard firewalls (front and rear) must remain in original position.
- b) All holes in firewalls must be filled with suitable material. Small holes (up to 3mm) and small gaps around wiring and radiator pipes may be filled with fire resistant sealant. Larger holes to be filled with minimum 0.9mm steel or aluminium.
- c) Rear firewall and parcel shelf to be covered with min 0.9mm steel or aluminium secured with bolts, pop rivets or welded.

13) RUB RAILS

- a) If vehicle has skeletonized / skinned doors (fiberglass / aluminium, metal / plastic replica), an outer and inner rub rail must be attached, specifications as follows: (Exception: if the driver's door only has been skeletonized/skinned, a rub rail is optional).
- b) Outer rub rails of 25mm x 25mm x 3mm RHS mild steel or aluminium to be securely mounted against body at a minimum of four points between wheel arches only on both sides. Rub rails not permitted on quarter panel behind rear wheel. Rub rail ends to be closed and taper to 45 degrees.
- c) Inner rub rail bar to be of a minimum 25mm x 25mm x 3mm RHS mild steel, or maximum 42mm x 3mm CHS mild steel and to be securely mounted to the chassis or roll cage at each end.
- d) Bolts must be a minimum 8mm Cup-Head bolts only and be bolted horizontally through outer and inner rub rails. There must be a bolt at each end within 50mm of the end of the rub rail. Bolts (inner and outer) are not to be recessed into RHS rails.

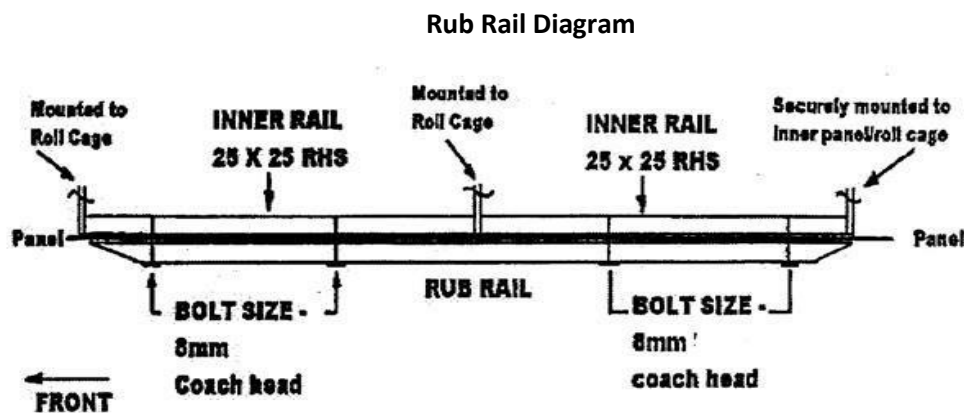

14) BUMPERS

- a) Must be original front and rear, or very similar in appearance. To be attached only to sub frame using original brackets or fitted over the top of optional bar work. No reinforcing whatsoever permitted. **Fibreglass or Plastic** Bumper Bars as per model must be replaced over optional bar work, if optional bar work is used, Steel bumpers do not have to be refitted over optional bar work. Ends of front and rear bumpers are to be attached to front guards and rear quarter panels to stop getting hooked. Maximum material permitted- 1.6mm x 50mm width of bar, using cup head bolts. The purpose of this is for securing Bumper Bar only.

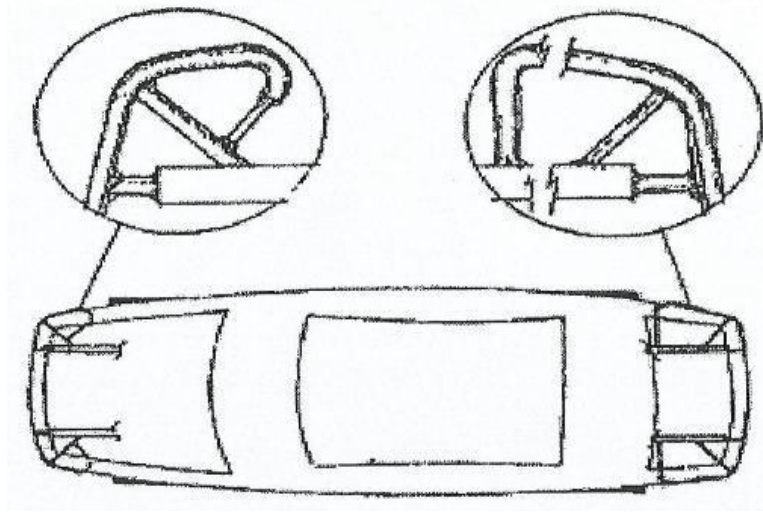

15) ROLL CAGE

a) Definitions

CHS	Circular Hollow Section
CDS	Cold Drawn Seamless
RHS	Rectangular Hollow Section
WT	Wall Thickness
ID	Inside Diameter
OD	Outside Diameter

b) General

- 1) The purpose of the roll cage is to prevent the collapse of the cabin area under impact. The cage must extend from behind the driver's seat forward to the windscreen area and incorporate protection for the driver's feet. The roll bars are to constitute a cage type framework, braced fore and aft. All roll cage bar-work is to be inside the body and within the cabin area. The roll cage is to enclose the driver and to be full width and full height of the cabin area.
- 2) No bolts/rivets/screws or holes of any sort are to be put in any roll cage structural tubing in the cabin area, except as described for floor bars where angle iron is used, and inner rub rail bars only.
- 3) All roll bar material must be of good quality mild steel, sizes for each bar as described in the following sections. Aluminium based materials not permitted Galvanized tubing or welding over threaded tubing not permitted in any structural bar work. Water pipe fittings or malleable fittings are not permitted.
- 4) All bends to be made using a pipe bender with the correct size former with no evidence of crimping, wall failure or significant weakening.
- 5) **NOTE:** Unless otherwise stated, all roll cage bars **including the Main Hoop bar must be made of one continuous length** of the appropriate material and built using fusion welding techniques only. Gussets may be required to welded joints.
- 6) Roll cage pipe padding is recommended around / near driver area to cushion the effects of any impact.

- 7) There are many variations in roll cage design mainly due to the different body shapes, especially in later models. These roll cage specifications describe the minimum elements that constitute an acceptable roll cage. Roll cages which exceed the requirements of the specifications through additional bars or the use of larger diameter tube are also acceptable provided all roll cage bar-work is to be inside the body and within the cabin area, and the roll cage is passed as safe. If in doubt, contact the RSA or State technical officer for the class to get a ruling as covered in this books 'Interpretation' section.
- 8) The specifications for the minimum elements of a roll cage follow. Unless otherwise specified, all bars are compulsory. Any additional roll cage bars must be of roll cage material, i.e., Minimum AS1163 Gr300 38mm OD x 3.0mm WT CHS (Sonic test at not less than 2.70mm ABSOLUTE) or 38mm O.D 2.6mm WT CDS tube (sonic test at not less than 2.4mm ABSOLUTE). Aluminium based materials not permitted.
- 9) If unsure in any aspect of the design or assembly of cage or any other roll cage compliance as stated within, contact the RSA for clarification. **NOTE:** This applies especially when using, modifying or retrofitting an earlier built existing cage.
- 10) The 'halo bar' style roll cage as shown in section 16.p (Optional external bar work) is permitted as an option to the roll cage design for the forward legs and top windscreen bar as described earlier in the roll cage section. The 'halo bar' extends forward along the inside of the door frame following the roof line from the main hoop to the top of the windscreen and back to the main hoop on the opposite side. The forward legs run from the 'halo bar' down the inside of the A-Pillar and inside door frame to the floor bars. Material to be as per roll cage bar work (minimum AS1163 Gr300 38mm OD x 3.0mm WT CHS or minimum 44.45mm OD x 2.6mm WT CDS).

c) Floor bars

Material: Minimum AS1163 Gr300 38mm OD x 3.0mm WT CHS or
Minimum 38mm OD x 2.6mm WT CDS or
Minimum 50mm x 50mm x 3mm RHS or
Minimum 50mm x 50mm x 5mm Angle iron.

The floor bars run from front to rear inside the cabin on each side as close to floor as practicable. At a minimum they must extend from the rear of the main hoop to front of the foot protection on the driver's side and the front of the forward roll cage leg on the passenger's side. They may extend as far forward or back as possible (e.g., to the rear wheel arch) as long as they are within the cabin area. If using CHS or RHS they must be securely welded to the floor panels/sills. If using angle iron, they must be welded or bolted to the floor panels/sills using at least four 12mm steel bolts through the subframe and using 100mm x 100mm x 3mm minimum plates under the floor.

a) Cross Braces

Material: Minimum AS1163 Gr300 38mm OD x 3.0mm WT CHS or
Minimum 38mm OD x 2.6mm WT CDS

The cross braces run from side to side between the floor bars as close to floor as practicable. The rear cross brace must line up with the main hoop. The front cross brace must be in the area from the front of the seat to the firewall. There are multiple options for front cross brace designs – refer to roll cage diagrams.

b) Main Hoop

Material: Minimum AS1163 Gr300 38mm OD x 3.0mm WT CHS or
Minimum 44.45mm OD x 2.6mm WT CDS.

The one-piece main hoop runs vertically from the floor bars on each side of the cabin following the profile of the doors and roof behind the driver and be within 50mm of the sides of the roof at the narrowest point.

A 3rd roll cage leg running from the centre of the main hoop to the centre of the front cross brace may be fitted as an alternative to the centre roof bar and the centre windscreen bar. If this bar is fitted, the top and bottom windscreen bars may be fabricated in two pieces (one on each side of the 3rd roll cage leg).

f) Quarter Window bars

Material: Minimum 25mm OD x 3.0mm WT CHS.

A quarter window bar, if required because of excessive rake or a long roll cage, must be fitted on both sides and installed from the top NASCAR door bar to roll cage leg at top half of the A pillar.

g) Top Windscreen bar

Material: Minimum AS1163 Gr300 38mm OD x 3.0mm WT CHS or
Minimum 38mm OD x 2.6mm WT CDS.

The top windscreen bar runs between the roll cage legs at the top of the windscreen area. It must be within 50mm of roof and 100mm of windscreen at front roll cage leg on side elevation.

h) Lower Windscreen bar

Material: Minimum AS1163 Gr300 38mm OD x 3.0mm WT CHS or
Minimum 38mm OD x 2.6mm WT CDS.

The lower windscreen bar runs between the roll cage legs at the bottom of the windscreen area.

i) Centre Roof bar

Material: Minimum 32mm OD x 3.0mm WT CHS or
Minimum 38mm OD x 2.6mm WT CDS.

The centre roof bar runs from the centre top of the main hoop to the centre of the top windscreen bar.

j) Centre Windscreen bar

Material: Minimum 25mm OD x 3.0mm WT CHS.

The centre windscreen bar runs from the centre of the top windscreen bar to the centre of the bottom windscreen bar.

Optional: Lower Windscreen bar to Cross Brace - recommended

It is recommended that an additional bar of 38mm OD x 3.0mm WT CHS be fitted between the lower windscreen bar and the forward cross brace if the cross brace is located sufficiently forward in the cabin so this bar is vertical or close to vertical.

k) Driver's side door bars & spacers

Material: Minimum AS1163 Gr300 38mm OD x 3.0mm WT CHS or
Minimum 38mm OD x 2.6mm WT CDS.

On the driver's (right) side three (3) horizontal side bars, curved out ('NASCAR' style) to the door skin, must be fitted between the main hoop and the front roll cage leg, evenly spaced between the window sill and the floor bar.

A minimum of two vertical spacer bars, evenly spaced between the front and rear roll cage legs, must be fitted between the floor bars and the top horizontal bar. The top horizontal NASCAR bar will be within 100mm of the windowsill.

Optional: One (1) only middle (not the top bar) driver's NASCAR door bar may extend or be extended through to the front of the rear wheel arch area and attach to the main hoop via a short bar forming a 'T' junction. This bar is not to be used as an inner rub rail mount.

****LEFT HAND SIDE (PASSENGER SIDE) TO BE MIRRORED OF DRIVERS SIDE IF PASSENGER SEAT FITTED.** Including foot protection, anti-spear plate and head plate. ***only applies to standard 4-cylinder sedans.

l) Passenger's side door bars – NASCAR Option

Material: Minimum AS1163 Gr300 38mm OD x 3.0mm WT CHS or
Minimum 38mm OD x 2.6mm WT CDS.

On the passenger's (left) side two (2) horizontal side bars, curved out ('NASCAR' style) to the door skin, must be fitted between the main hoop and the front roll cage leg, evenly spaced between the window sill and the floor bar.

A minimum of one vertical spacer bar, evenly spaced between the front and rear roll cage legs, must be fitted between the floor bars and the top horizontal bar. The top horizontal NASCAR bar will be within 100mm of the window sill.

Optional: One (1) only middle (not the top bar) passenger's NASCAR door bar may extend or be extended through to the front of the rear wheel arch area and attach to the main hoop via a short bar forming a 'T' junction. This option is only available with the NASCAR option for passenger door bars. This bar is not to be used as an inner rub rail mount.

Passenger's side door bars – Alternative

Material: Minimum AS1163 Gr300 38mm OD x 3.0mm WT CHS or
Minimum 38mm OD x 2.6mm WT CDS.

On the passenger's (left) side one (1) straight (not curved) horizontal side bar, must be fitted between the main hoop and the front roll cage leg, within 100mm of the windowsill.

An additional diagonal bar may be fitted (shown in diagram) between the main hoop and the front roll cage leg under the horizontal door bar from rear to corner to bottom front corner.

m) Rearward brace bars (optional)

Material: Minimum 34mm OD x 3mm WT CHS
Minimum 34mm OD x 2.6mm WT CDS.

The rearward brace bars run from the top rear main hoop down onto cabin or boot floor sub-frame, firewall, parcel tray or wheel arch areas (approx. 45 degrees) and may be crucifix. Bars in boot area must terminate inward from rear boot panel. Bars may attach down to rear bumper return pipes (if fitted). They must attach to the rearward side of the main hoop within 100mm of the centre of the top radius.

n) Head Plate

Must be mirrored on passenger side bar work if passenger seat fitted. ***only applies to standard 4-cylinder sedans.

Material: Minimum 3mm steel plate or 5mm aluminium alloy plate.

A full head protection plate must be fitted to fully cover the area between the main hoop and top windscreen bar from the centre roof bar to the top of the roll cage leg on the drivers' side. When sitting, and belted in seat, there must be a minimum of 50mm clearance between helmet and head plate. Steel plate may be welded on or bolted on, alloy plate must be bolted on.

Welded option: to be mounted from above the roll cage bars and to be a minimum stitch welded to roll cage.

Bolted option: to be mounted from above the roll cage bars and bolted to minimum 10 tabs (3 tabs on each side, 2 front and 2 rear) of 50mm x 50mm x 3mm steel welded to roll cage using minimum 10 x 8mm high tensile bolts (one bolt per tab).

Roll Cage Diagrams

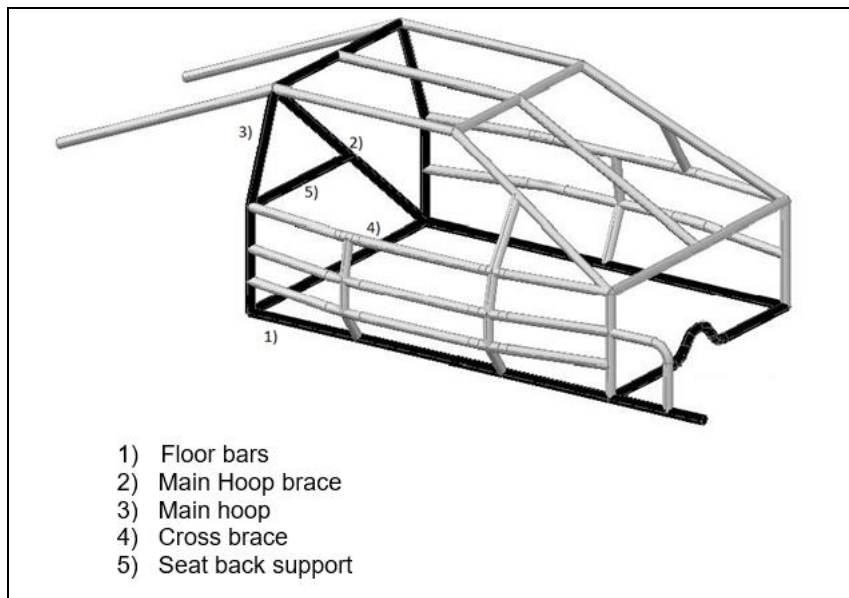

Front Cross brace design options

A. Old Style Cross Brace

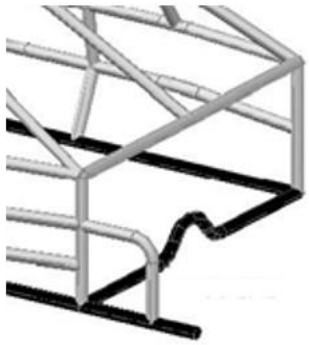

B. Later models with higher tunnels



C. 'Fuller' Cross Brace



D. As used in other divisions

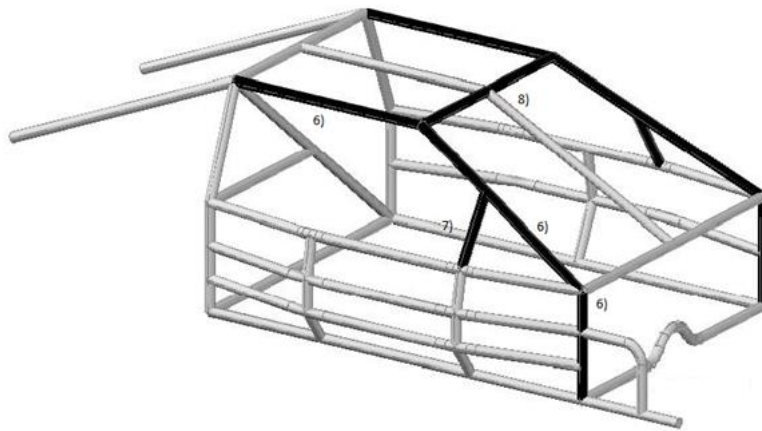

- 6) Roll cage leg
- 7) Quarter window bar
- 8) Top windscreen bar

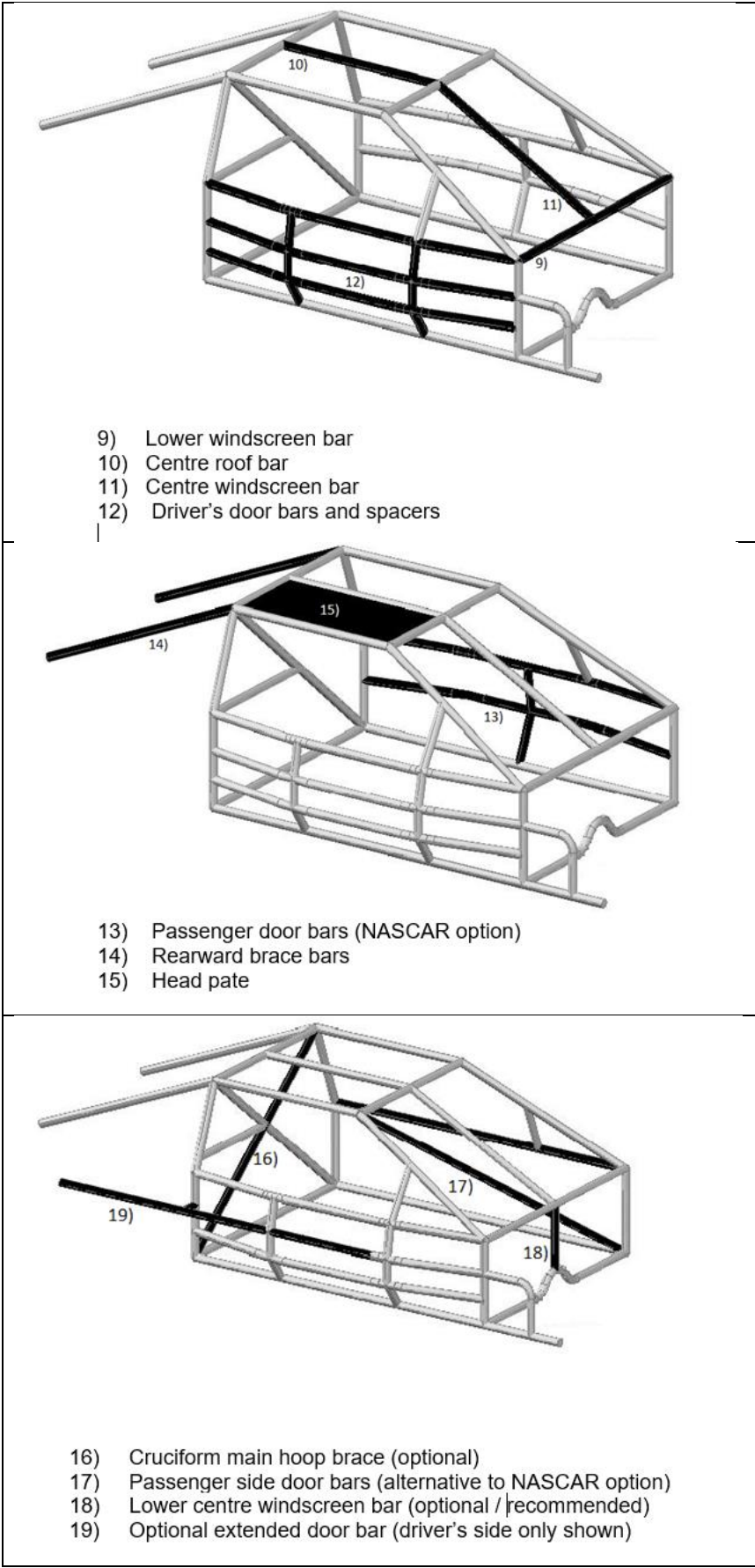

o) Optional external bar work

Material: Maximum AS1163 Gr300 38mm OD x 3.0mm WT CHS or
 Maximum 38mm OD x 2.6mm WT CDS or

- a. Bar work can be attached to roll cage.
- b. Vehicles with plastic bumpers must have the bar work behind the bumpers. Front bar work maximum return 300mm, minimum 100mm. Corners and ends of front and rear bumpers to be radius formed, 100mm minimum.
- c. Maximum of four mounting points on each bumper bar. Returns and bumpers to be flush fitting with the body rear only. Returns of rear bumper may be extended as a skid rail against outside of the body between the bumper and wheel arch, and then extend inward to the bar work.
- d. Gussets are not permitted.

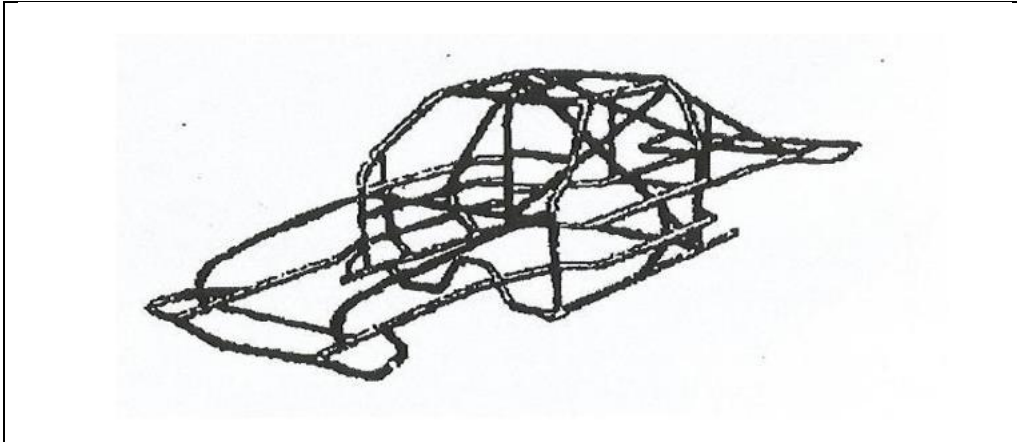

p) Scattershield

Material: Minimum 3mm steel plate or minimum 5mm alloy

All front engine cars must fit a scattershield except east-west cars where the projection line of the clutch is not on the driver's side of the vehicle (for these cars it is recommended but not mandatory). To be a minimum of 250mm wide, must cover the upper 180 degrees of bell housing, and must be securely attached to the bell housing or fire wall in engine bay, or front fire wall in cabin area. Scattershield must protect the driver's feet and legs in the event of a clutch explosion.

16) ANTI-SPEAR PLATE / FOOT PROTECTION

a) Anti-Spear plate

Must be mirrored on passenger side bar work if passenger seat fitted. ***only applies to standard 4-cylinder sedans.

Material: Minimum 3mm steel plate or 5mm aluminium alloy plate

Either a one-piece plate or 3 individual plates of 3mm steel or 5mm alloy must be fitted to form an anti-spear external cage plate on the driver's side NASCAR bars from floor-line to window sill bar, forward of

the first vertical door bar to the front leg of roll cage. Not to be lightened by drilling. The anti-spear plate may be extended to 2nd spacer bar on the driver's side NASCAR bars as an option.

Steel plate: to be a minimum stitch welded (preferably fully welded) to roll cage.

Alloy plate one-piece plate: to be bolted to minimum 6 tabs of 50mm x 50mm x 3mm steel welded to roll cage using minimum 6 x 8mm high tensile bolts (one bolt per tab).

Alloy plate individual pieces: each plate to be bolted to minimum 4 tabs of 25mm x 25mm x 3mm steel welded to roll cage using minimum 4 x 8mm high tensile bolts (one bolt per tab).

b) Foot Protection bar work

Must be mirrored on passenger side bar work if passenger seat fitted. *only applies to standard 4-cylinder sedans.**

Material: Minimum 3mm steel plate or 5mm aluminium alloy plate
Minimum AS1163 Gr300 38mm OD x 3.0mm WT CHS.

Foot protection bar work is mandatory if drivers' feet are past the A pillar bar whilst the driver is seated in the car in race position. The minimum requirement for foot protection a curved bar of minimum 38mm OD x 3.0mm WT extending forward from the A-pillar bar to the floor bar in the footwell of the driver's side. The internal area formed by the foot protection bar must be filled with minimum 3mm steel plate either stitch or fully welded to the foot protection bar.

Alloy plate one-piece plate: to be bolted to minimum 4 tabs of 50mm x 50mm x 3mm steel welded to roll cage using minimum 4 x 8mm high tensile bolts (one bolt per tab).

If practical, straight leg fitment of driver's side A-pillar bar through to subframe floor bar intersecting at firewall, is permitted as an option for the foot protection bar.

A support bar min 25mm OD x 3mm WT must be fitted from the foot protection bar to bar work to the left.

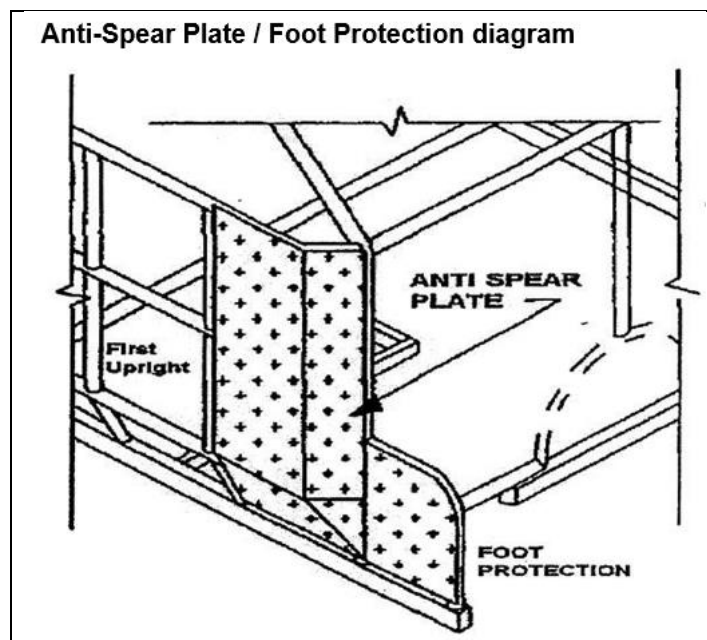

17) COOLING SYSTEM

- a) Cooling system may be modified.
- b) Maximum of two (2) radiators permitted.
- c) Radiators may be mounted inside cabin provided that they are mounted as low as possible in the rear of the vehicle rearward of the roll cage main hoop. The upper half of rear window opening MUST NOT be obscured by the rear radiator. Radiator ducting shroud must not be more than half the rear window height.
- d) If a professionally fabricated aluminium racing radiator is used with the tanks TIG welded to the core, the tanks are not required to be covered, but radiator cap must be covered. Examples of this are racing radiators produced by KENCO and AFCO. All other cabin mounted radiators must have BOTH tanks and cap covered to protect the driver (and passenger if applicable) in the event of the rad cap blowing off or tank splitting.
- e) All pipes in the cabin area must be covered / lagged and shielded to protect driver in the event of a hose or pipe leak. No household carpet, cloth or similar material permitted to be used to wrap water pipes.
- f) All radiator hoses to be of fabric reinforced material, no plain rubber hoses permitted. Hoses to be as short as possible and fitted to radiator from rear side. Exposed hoses or joints not permitted in cabin area.
- g) Radiator in engine bay must be in its original position. No cutting out of bodywork to make it fit. Radiator support panel bracing is permitted only if running a radiator in the front - maximum material 25mm x 25mm x 3mm RHS Tubing or Angle. Bracing permitted back to the edge of the sub frame. Bracing must not protrude more than 50mm in front of radiator.
- h) Radiator cap must be lever vent type and must be shielded.
- i) Radiator cap overflow to be fitted with a hose to direct steam to the ground. The use of radiator expansion tanks is limited - MAXIMUM 2 litres.
- j) Cabin mounted fans to have shroud or suitable guard.
- k) Electric water pumps allowed. Standard class and modified.
- l) Cabin mounted water pumps must be lagged or covered by suitable guard.
- m) Radiator water spray systems are not allowed.

18) EXHAUST

- a) Exhaust must be within noise level requirements of each track. (Check before you attend)
- b) Muffler must be fitted to the engine pipe, which must be securely mounted and bracketed. Original exhaust manifold or (extractors may be used 2 litres only). Floor may be shaped to lift muffler.
- c) Outlet to be behind driver seat. Exhaust system must not pass-through cabin. All exhaust gases must be directed away from driver, tyres and fuel tank.

19) FUEL TANK

- a) Vehicle's manufactured fuel tank not permitted and must be completely removed. Fuel tank to be either approved racing tank or suitably manufactured tank of minimum 16-gauge steel, stainless steel, 3mm aluminium.
- b) Maximum capacity- 40 litres.
- c) Fuel tanks must be mounted in an upright position. Contact area must be a minimum 300mm from rear and sides of boot area. Tank must be securely fastened. Boot must be able to be opened for scrutineering and inspection of fuel tank area. Area beneath fuel tank must have adequate ventilation in the event of a spillage during refuelling.
- d) Tanks (includes filler neck) must be isolated from the driver by a steel or Aluminium firewall or suitable enclosure. All tanks must be accessible via a quick release mechanism that does not require tools to open.
- e) Commercially produced plastic racing fuel tanks permitted but must have an earth strap fitted from the plastic fuel cell filler neck to roll cage or chassis as an earth to prevent build-up of static electricity.
- f) A breather pipe is to be fitted to fuel tank and fitted with a suitable valve to seal in the event of a roll over. Alternatively, a pig tail is to be fitted and the breather pipe wrapped around fuel tank or the breather pipe is to be wrapped around the fuel tank on all sides before passing through the floor and directed away from the exhaust system.
- g) Breather and return line (if fitted) fittings to be attached to top of fuel tank. Pick-up fitting to be attached to top, sides or bottom of fuel tank.
- h) Fuel lines must be first grade fuel line or original EFI system, for EFI engine cars, fuel lines must be EFI grade High Pressure lines, securely fastened. A clearly marked ON/OFF fuel tap must be used (within easy reach of the driver). Tap not required for EFI engines. If fuel line running under car tap not required. All fuel lines and electrical wiring must be separated and not taped together, must be fitted with grommets when passing through metal firewalls etc. and must be taped and secured where chafing can occur.
- i) Fuel Lines – EFI cars. Optional - 'Push Lock' fittings and SAE 100 R6 spec fuel hose (examples of both pictured below) are permitted and may be used as a combination without hose clamps. Note that the correct spec hose must be used with this type of fitting, and the fitting is unsuitable for use with standard EFI or Carby fuel hose.

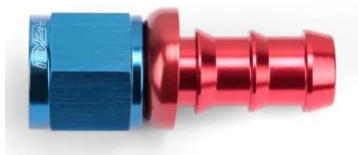

- j) Must have rubber under fuel tank mounting areas and straps.

19.1) Fuel Tank Protection – overslung tanks

- a) An overslung tank is mounted above the rear chassis bars.
- b) Fuel tank protector bar must attach to the rear chassis bars and be constructed of minimum 38mm x 3 mm CHS. This bar must be minimum 25mm higher than top of tank.
- c) Fuel tank protector bar to be braced forward with minimum 25mm x 25mm x 3mm RHS or minimum 25mm x 3mm CHS on both sides with 25mm clearance all around the tank and filter. Bar is to prevent side entry to tank and brace fuel tank protector bar from rear impact.

19.2) Fuel Tank Protection – underslung tanks

- a) An underslung tank is mounted below the rear chassis bars.
- b) Fuel tank protector bar must attach to the rear chassis bars and be constructed of minimum 38mm x 3 mm CHS. This bar must be minimum 25mm lower than bottom of tank.
- c) Fuel tank protector bar to be braced forward with minimum 25mm x 25mm x 3mm RHS or minimum 25mm x 3mm CHS on both sides with 25mm clearance all around the tank and filter. Bar is to prevent side entry to tank and brace fuel tank protector bar from rear impact. This bar must be 50mm wider than both sides of the tank and min. height of 150mm or 75% of the height of the tank, whichever is greatest.
- d) Fuel tank protection diagram:

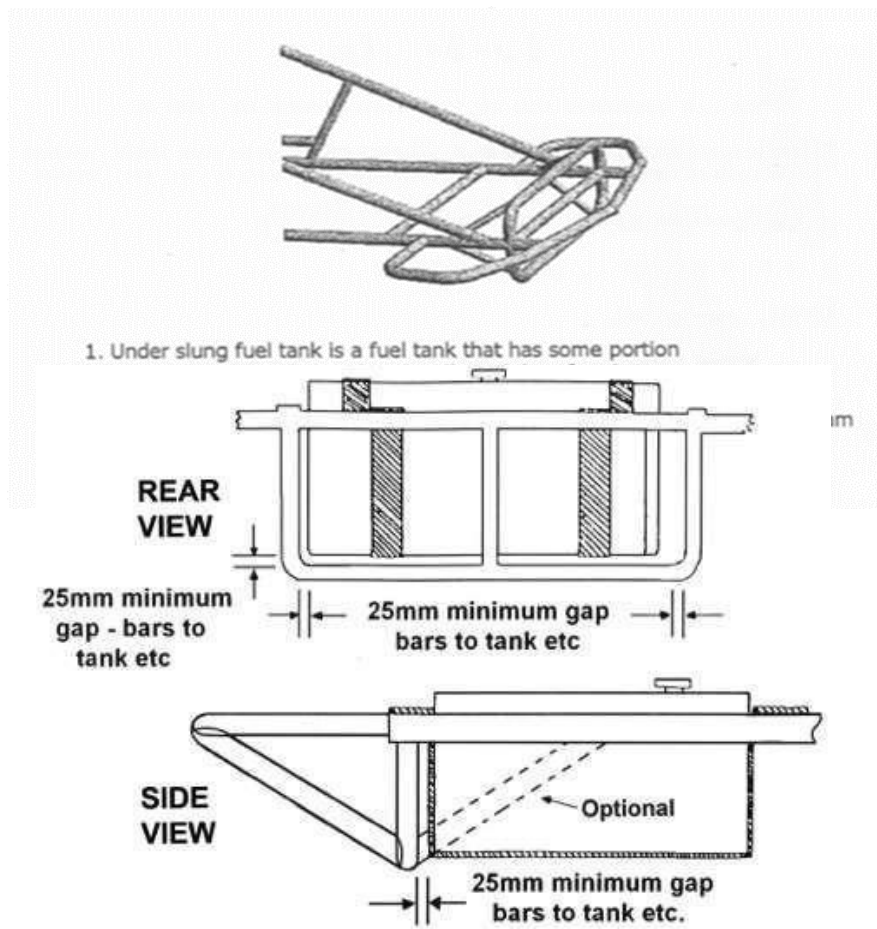

20) FUEL

- a) ULP only.
- b) Petrol only. Unleaded or premium unleaded pump fuel only and must come from a retail service station EG: Caltex, BP, Shell. Max 98 octane.
- c) No additives, maximum specific gravity 0.780, maximum 98 octane. Must be supplied by a commercial outlet through a multi-volume network via bowser pump. Fuel may be tested by any means.
- d) Use of cooling systems for fuel is not allowed.

21) SUSPENSION

- a) Suspension must remain the same suspension that came out fitted to the vehicle.
- b) Standard coils may be swapped for aftermarket models provided original mounting points are used and not modified. Gas, Decarbon shock absorbers permitted. IE: spring saddles must be at original heights and not be adjustable in any way.
- c) No coil over permitted. No air shock absorbers. Cutting or welding of suspension components not permitted. Limiting suspension travel by use of chains not permitted.
- d) A spreader bar is permitted for struts between shock towers (maximum material permitted 25mm x 25mm x 3mm RHS). Bars may be fitted from the top rear of strut towers to the centre of lower windscreen bar (roll cage material).
- e) No lowering or jacking permitted by use of weight jackers or adjusters. Random check after scrutineering will happen to help police this matter and a severe penalty will be given if found guilty.
- f) Front and Rear suspension:
 - a) Aftermarket camber caster kit EG: Pedders, Whiteline ALLOWED to TOP ONLY (max 5 degree).
 - b) Aftermarket camber bolts (e.g. K-Mac) ALLOWED to BOTTOM ONLY. Bolt only is allowed with no other attachments, additions/modifications to strut base or lower control arm mounting points.
 - c) Camber bolts permitted on lower strut leg to stub axle to obtain max 5 degrees of camber.
 - d) One camber bolt per strut leg to be used, fitted to either top or bottom hole, not both and one factory bolt must remain.
 - e) Sway bars optional.
 - f) NO handmade suspension parts PERMITTED.
 - g) NO extension of lower control arm PERMITTED.
 - h) NO widening of wheel track PERMITTED.
- g) A support bar may be fitted to strengthen the original mounting points of the rear control arms but must be fitted between existing body mounting points. Only existing bolt holes on body mounts may be used. No additional brackets or mounting points permitted. Maximum material permitted 50mm X 50mm X 3mm square tube with drilled flat plate welded at each end. Angle iron (max 50mm x3mm) may also be used.

22) WHEELS

- a) Composite type wheels NOT acceptable. Composite wheel means wheels made of different materials e.g., 3-piece alloy wheels are not classed as composite wheels.
- b) Rim size optional. All wheels to be max 165mm wide x 15" diameter. All four wheels to remain same diameter on vehicle at any one time.
- c) Wheels must be in good condition and free from cracks. Rim edges to be rolled or rounded off if rim protrudes past tyre walls. Standard manufactured steel or alloy wheels, including aftermarket steel or alloy permitted. No wire or dual wheels permitted.
- d) STANDARD wheel off set, NO deep dish off set on FWD cars to extend wheel track. All wheels must have the same offset.
- e) Custom made wheels NOT PERMITTED.

- f) Tyre/rim combination must not protrude beyond original body line. Flaring of guards not permitted, wheel arches must remain standard.
- g) All wheel studs and nuts must be in good condition and used. Wheel nuts taper and wheel chamfer must match. Wheel studs not to protrude further than ½ inch (12mm) past the outer face of the wheel nut. Wheel studs minimum 11mm. Wheel weights not permitted.
- h) Wheel spacers permitted MAXIMUM 10mm per wheel.
- i) Fitting of longer wheel studs to accommodate a 10mm spacer permitted. Wheel studs must not protrude excessively past wheel nut or the face of the wheel.
- j) Wheel weights not permitted.

23) TYRES

- a) Tyres not to sit outside body.
- b) Tyre dimensions maximum of 235 wall marking. Tyres to be Australian road legal radial rated tyre. Tyres must have been listed in a road car tyres section of a manufacturers tyre catalogue for Australia.
- c) Tyre casings to have speed, size and load ratings indicated. Re-tread tyres must have the correct re moulders speed rating etc. and be legible as per AS 1973– 1985.
- d) Re-grooving of tyres permitted.
- e) No rally, snow, mud, Hoosier, American racers, Yokohama A050, Achilles 123 or any DOT or E marked tyres not listed in the road tyre sections of the manufactures catalogue and/or never intended to be driven on public roads but made exclusively for motor sport use only.
- f) All tyres must meet a minimum 50 durometer reading.
- g) All tyre tread wear indicator must be minimum 200. Tyres with no tread wear ratings refer to technical committee or Racing Sedans Australia committee for clarification. Safety inner air tube is allowed.

23) BRAKES

- a) Must be OEM for model being used.
- b) Race cars must be fitted with effective brakes on all four (4) wheels, handbrakes highly recommended. No taps permitted. Not necessary to lock up.
- c) ABS brake systems may be used for any model produced with ABS as an OEM option.

24) STEERING

- a) Left hand drive not permitted. Modifications are not permitted to steering which must remain standard and in sound condition. Rose joint permitted at top mounting if no modification to original column with the exception of the top 300mm of the steering column to allow for the fitment of a quick release steering wheel and rose joint.
- b) Power Steering optional provided it is as per production line, for model.
- c) Centre of steering wheel must be padded. Original or sports type steering wheels permitted. Wire spoke, or wood rim steering wheels are not permitted.

- d) Original or sports type steering wheels approved. Wire spoke, or wood rim steering wheels are NOT permitted. QUICK RELEASE STEERING WHEELS – Compulsory. Steering wheel quick release hub to be professionally manufactured. To be made of aluminium or steel. NO PLASTIC. Recommended that retaining pin be an integral part of the hub. Steering position to remain standard.
- e) Centre of steering wheel must be padded.
- f) Steering column and shaft may be replaced with a 19mm x 2mm seamless tube to the first joint in the steering shaft.
- g) Steering column must pass through a steel loop 12 mm thick or a 3/4" rose joint, bolted or welded to the dash bar. No chain or exhaust clamps permitted.
- h) The use of professionally made after market steering column mounts as shown below is permitted. Mounts must be in original position and not to be used to offset steering position. Must be securely mounted to lower windscreen bar.



25) TRANSMISSION

- a) ELECTRONIC TRACTION CONTROL NOT PERMITTED.
- b) Standard factory gearbox must be used as per model. Three (3), Four (4), or Five (5) speed gearboxes can be interchanged but must be from the same parent manufacturer. Ratios are optional but must be from same make or optional model.
- c) Straight or split tail shafts may be used to suit gearboxes and diffs.
- d) Rear wheel drive must have a steel strap or chain the front of the tail shaft 150mm to the rear of the front universal joint. Loop is to have a maximum clearance of 50mm below the tail shaft. If split tail shaft, must have a loop on each universal. Material to be a minimum 5mm chain or 40mm x 5mm flat bar or equal.
- e) Race cars must have a minimum of two (2) forward and one (1) reverse gear. Gear lever shall be rendered harmless by the use of suitable knobs, handles etc. Any floor shift lever shall be fitted with a suitable boot to cover the gear shift hole in the floor pan. There will be no multiple gear shift levers. Neutral/inhibitor safety switch or brake switches to be installed and working on all AUTOMATIC models.
- f) Every race car must be able to be started and then the vehicle can be put into gear and moved off in a forward or reverse direction as required.

26) DIFFERENTIAL

- a) Ratios may be altered if crown wheel and pinion only are changed. Must fit housing. There will be no quick-change diffs permitted.

- b) All rear wheel drive Diffs must be locked, front wheel drive optional. Four (4) wheel drives not permitted.
- c) Rear axles bearing retaining collar rings to be tack welded to axle. Maximum two (2) tacks 5mm long, using a small diameter, low hydrogen rod on low amperage. If axle is lost and it is found that this has not been done, driver will be penalised.
- d) For rear wheel drive cars, the left and right-side wheel base length must not change during racing. (No linked or walking diffs allowed).

27) ENGINES

27.1) Carburetted engines

- a) Four cylinders maximum. **(Engine capacity 2070cc absolute maximum for standard 4 Cylinder Sedans).**
- b) Up to four(4) cylinders only. Rotary, Turbocharged, Supercharged, or Special Race Rally packs NOT permitted. Motors interchangeable are permitted engine as per vehicle model fitted by manufacture e.g.: Corolla to Corolla, Pulsar to Pulsar, Civic to Civic. Engines must be an original factory option for the car make/model. All new vehicles built from 1st June 2023 must use engine as per model fitted by manufacturer. Maximum 100kw factory rated.
- c) Engine to remain visually standard per model with everything operational, with the exception of fan blades (not required), chokes and pollution equipment.
- d) 16 valve carburettor engines must remain completely standard as per manufacturer's specifications with the exception of carby change rule.
- e) The following items must remain standard as per manufacturer's specifications for the engine being used:
 - Manufacturer's markings to remain on engine block castings.
 - Engine position.
 - Crankshaft.
 - Engine stroke.
 - Con rods.
 - Piston type (up to 0.060" oversize permitted, but must remain standard type).
 - Camshafts and cam followers.
 - Cylinder heads - no porting, polishing or port matching.
 - Valves and port sizes.
 - Crankshaft, alternator, and water pump pulleys.
 - Flywheel (no lightening or machining), clutch and pressure plate.
 - Alternator.
 - Water pump (electric water pumps not permitted).
 - Engine oil coolers (permitted only if factory fitted on production model - no aftermarket auxiliary oil coolers permitted).
 - No after-market or performance enhancing types of ignition permitted (standard electronic ignition is permitted).
 - Exhaust manifold.
- f) The following modifications and changes are permitted (excludes 16 valve engines which must remain standard):
 - Cylinder overbore (maximum 0.060" oversize).
 - Cylinder head facing (maximum 0.030").
 - Engine block deck machining (maximum 0.010" from standard).
 - Cross member may be changed to suit motor, but no cutting or welding permitted.

- Oil coolers permitted in Autos.

Carburettor

- a) Any standard factory single or dual throat carburettor permitted.
- b) Manifold may be modified to accept adaptor plate. No adaptor plate to be more than 25mm thick.
- c) An extra return spring must be fitted to main throttle shaft.
- d) Manifold and/or carburettor may be fitted to injected motor with minor modifications.

27.2) Fuel Injected engines

- a) Traction control not permitted.
- b) Up to four(4) cylinders only. Rotary, Turbocharged, Supercharged, or Special Race Rally packs NOT permitted. Motors interchangeable are permitted engine as per vehicle model fitted by manufacture e.g.: Corolla to Corolla, Pulsar to Pulsar, Civic to Civic. Engines must be an original factory option for the car make/model. All new vehicles built from 1st June 2023 must use engine as per model fitted by manufacturer. Engine capacity MAX 1600cc. Maximum 100kw factory rated.
- c) Restrictor Plates may be required on all fuel injected cars during the life of this specification book.
- d) Engine to remain visually standard per model with everything operational, with the exception of fan blades (not required) and pollution equipment.
- e) Engine to remain stock standard including exhaust and intake manifolds as per engine model. Aftermarket pod style filters and intake tubes permitted.
- f) The following items must remain standard as per manufacturer's specifications for the engine being used:
 - Manufacturer's markings to remain on engine block castings.
 - Engine position.
 - Crankshaft.
 - Engine stroke.
 - Con rods.
 - Piston type (up to 0.060" oversize permitted, but must remain standard type).
 - Camshafts and cam followers.
 - Cylinder heads - no porting, polishing or port matching.
 - Valves and port sizes.
 - Crankshaft, alternator, and water pump pulleys.
 - Flywheel (no lightening or machining), clutch and pressure plate.
 - Alternator.
 - Distributor (must remain standard for engine being used).
 - Water pump.
 - Engine oil coolers (permitted only if factory fitted on production model - no aftermarket auxiliary oil coolers permitted).
 - No after-market or performance enhancing types of ignition permitted (standard electronic ignition is permitted).
 - Original exhaust manifold & Engine pipe size MUST be used.
- g) The following modifications and changes are permitted:
 - Cylinder overbore (maximum 0.060" oversize).
 - Cylinder head facing (maximum 0.030").
 - Engine block deck machining (maximum 0.010" from standard).

- Cross member may be changed to suit motor, but no cutting or welding permitted.
- Electric water pump may be fitted BUT original water pump must still work.
- Oil coolers permitted in Autos.

Fuel Injection

- a) Standard electronic ignition, injection and computer to be used as per engine model.
- b) Computer can be interchanged at any event at the direction of the scrutineer. Failure to comply will result in exclusion from the meeting for car and driver. Further penalties may apply.
- c) At any time, RSA has the right to enforce a control computer on this division.

28) BODY KIT AND SPOILER

- a. There are many makes and models of spoilers, so any final interpretation of fitment will be up to the RSA Executive/Tech officer.
- b. Sports model body kits may be fitted.
- c. Open bonnet scoops not permitted.
- d. Rear spoilers are allowed but must be polycarbonate, fibreglass or plastic only and of a mass-produced store-bought item. No steel, aluminium or homemade will be allowed.
- e. Maximum height must not to exceed 150mm from top of boot lid to uppermost point of spoiler.
- f. Spoiler to not extend past the line of the rear quarter panels and must be firmly fixed. Hatchback spoiler to remain in OEM mounting position (if an option for model) not to exceed 150mm in height.

Appendix 1 – Limited Approvals 2024-25 season

The following optional specifications have been approved until the date of the 2025 AGM. Any permanent approval after that date is dependent on these specifications being passed at the 2025 AGM.